

**HIKVISION**



# **Video Intercom Indoor Station**

User Manual

UD02905B

**User Manual**

©2016 Hangzhou Hikvision Digital Technology Co., Ltd.

This user manual is intended for users of the models below:

| Series                    | Model         |
|---------------------------|---------------|
| Indoor Station (6-Series) | DS-KH6310-W   |
|                           | DS-KH6310     |
|                           | DS-KH6310-WL  |
|                           | DS-KH6210-L   |
| Indoor Station (8-Series) | DS-KH8301-WTS |
|                           | DS-KH8301-WT  |
|                           | DS-KH8300-T   |

It includes instructions on how to use the Product. The software embodied in the Product is governed by the user license agreement covering that Product.

**About this Manual**

This Manual is subject to domestic and international copyright protection. Hangzhou Hikvision Digital Technology Co., Ltd. (“Hikvision”) reserves all rights to this manual. This manual cannot be reproduced, changed, translated, or distributed, partially or wholly, by any means, without the prior written permission of Hikvision.

**Trademarks**

**HIKVISION** and other Hikvision marks are the property of Hikvision and are registered trademarks or the subject of applications for the same by Hikvision and/or its affiliates. Other trademarks mentioned in this manual are the properties of their respective owners. No right of license is given to use such trademarks without express permission.

**Disclaimer**

TO THE MAXIMUM EXTENT PERMITTED BY APPLICABLE LAW, HIKVISION MAKES NO WARRANTIES, EXPRESS OR IMPLIED, INCLUDING WITHOUT LIMITATION THE IMPLIED WARRANTIES OF MERCHANTABILITY AND FITNESS FOR A PARTICULAR PURPOSE, REGARDING THIS MANUAL. HIKVISION DOES NOT WARRANT, GUARANTEE, OR MAKE ANY REPRESENTATIONS REGARDING THE USE OF THE MANUAL, OR THE CORRECTNESS, ACCURACY, OR RELIABILITY OF INFORMATION CONTAINED HEREIN. YOUR USE OF THIS MANUAL AND ANY RELIANCE ON THIS MANUAL SHALL BE WHOLLY AT YOUR OWN RISK AND RESPONSIBILITY.

TO THE MAXIMUM EXTENT PERMITTED BY APPLICABLE LAW, IN NO EVENT WILL HIKVISION, ITS DIRECTORS, OFFICERS, EMPLOYEES, OR AGENTS BE LIABLE TO YOU FOR ANY SPECIAL, CONSEQUENTIAL, INCIDENTAL, OR INDIRECT DAMAGES, INCLUDING, AMONG OTHERS, DAMAGES FOR LOSS OF BUSINESS PROFITS, BUSINESS INTERRUPTION, SECURITY BREACHES, OR LOSS OF DATA OR DOCUMENTATION, IN CONNECTION WITH THE USE OF OR RELIANCE ON THIS MANUAL, EVEN IF HIKVISION HAS BEEN ADVISED OF THE POSSIBILITY OF SUCH DAMAGES.

SOME JURISDICTIONS DO NOT ALLOW THE EXCLUSION OR LIMITATION OF LIABILITY OR CERTAIN DAMAGES, SO SOME OR ALL OF THE ABOVE EXCLUSIONS OR LIMITATIONS MAY NOT APPLY TO YOU.

**Support**

Should you have any questions, please do not hesitate to contact your local dealer.

## Regulatory Information

### FCC Information

Please take attention that changes or modification not expressly approved by the party responsible for compliance could void the user's authority to operate the equipment.

**FCC compliance:** This equipment has been tested and found to comply with the limits for a Class A digital device, pursuant to part 15 of the FCC Rules. These limits are designed to provide reasonable protection against harmful interference when the equipment is operated in a commercial environment. This equipment generates, uses, and can radiate radio frequency energy and, if not installed and used in accordance with the instruction manual, may cause harmful interference to radio communications. Operation of this equipment in a residential area is likely to cause harmful interference in which case the user will be required to correct the interference at his own expense.

### FCC Conditions

This device complies with part 15 of the FCC Rules. Operation is subject to the following two conditions:

1. This device may not cause harmful interference.
2. This device must accept any interference received, including interference that may cause undesired operation.

### EU Conformity Statement



This product and - if applicable - the supplied accessories too are marked with "CE" and comply therefore with the applicable harmonized European standards listed under the EMC Directive 2004/108/EC, the RoHS Directive 2011/65/EU.



2012/19/EU (WEEE directive): Products marked with this symbol cannot be disposed of as unsorted municipal waste in the European Union. For proper recycling, return this product to your local supplier upon the purchase of equivalent new equipment, or dispose of it at designated collection points. For more information see: [www.recyclethis.info](http://www.recyclethis.info)



2006/66/EC (battery directive): This product contains a battery that cannot be disposed of as unsorted municipal waste in the European Union. See the product documentation for specific battery information. The battery is marked with this symbol, which may include lettering to indicate cadmium (Cd), lead (Pb), or mercury (Hg). For proper recycling, return the battery to your supplier or to a designated collection point. For more information see: [www.recyclethis.info](http://www.recyclethis.info)

### Industry Canada ICES-003 Compliance

This device meets the CAN ICES-3 (A)/NMB-3(A) standards requirements.



## Safety Instruction

These instructions are intended to ensure that user can use the product correctly to avoid danger or property loss.

The precaution measure is divided into **Warnings** and **Cautions**:

**Warnings:** Neglecting any of the warnings may cause serious injury or death.

**Cautions:** Neglecting any of the cautions may cause injury or equipment damage.

|   |  |
|---|--|
|  |         |
| <b>Warnings</b> Follow these safeguards to prevent serious injury or death.       | <b>Cautions</b> Follow these precautions to prevent potential injury or material damage. |



### Warnings

All the electronic operation should be strictly compliance with the electrical safety regulations, fire prevention regulations and other related regulations in your local region.

Please use the power adapter, which is provided by normal company. The power consumption cannot be less than the required value.

Do not connect several devices to one power adapter as adapter overload may cause over-heat or fire hazard.

Please make sure that the power has been disconnected before you wire, install or dismantle the device.

When the product is installed on wall or ceiling, the device shall be firmly fixed.

If smoke, odors or noise rise from the device, turn off the power at once and unplug the power cable, and then please contact the service center.

If the product does not work properly, please contact your dealer or the nearest service center. Never attempt to disassemble the device yourself. (We shall not assume any responsibility for problems caused by unauthorized repair or maintenance.)



### Cautions

Do not drop the device or subject it to physical shock, and do not expose it to high electromagnetic radiation. Avoid the equipment installation on vibrations surface or places subject to shock (ignorance can cause equipment damage).

Do not place the device in extremely hot (refer to the specification of the device for the detailed operating temperature), cold, dusty or damp locations, and do not expose it to high electromagnetic radiation.

The device cover for indoor use shall be kept from rain and moisture.

Exposing the equipment to direct sun light, low ventilation or heat source such as heater or radiator is forbidden (ignorance can cause fire danger).

Do not aim the device at the sun or extra bright places. A blooming or smear may occur otherwise (which is not a malfunction however), and affecting the endurance of sensor at the same time.

Please use the provided glove when open up the device cover, avoid direct contact with the device cover, because the acidic sweat of the fingers may erode the surface coating of the device cover.

Please use a soft and dry cloth when clean inside and outside surfaces of the device cover, do not use alkaline detergents.

Please keep all wrappers after unpack them for future use. In case of any failure occurred, you need to return the device to the factory with the original wrapper. Transportation without the original wrapper may result in damage on the device and lead to additional costs.

Improper use or replacement of the battery may result in hazard of explosion. Replace with the same or equivalent type only. Dispose of used batteries according to the instructions provided by the battery manufacturer.

# Table of Contents

|  |           |
|--|-----------|
| <b>1 Overview</b> .....  | <b>1</b>  |
| 1.1 Introduction.....  | 1         |
| 1.2 Main Features.....   | 1         |
| <b>2 Appearance</b> .....  | <b>2</b>  |
| 2.1 Appearance of DS-KH8301-WTS/DS-KH8301-WT/ DS-KH8300-T.....               | 2         |
| 2.2 Appearance of DS-KH6310-W/DS-KH6310.....                                 | 3         |
| 2.3 Appearance of DS-KH6310-WL/DS-KH6210-L.....                              | 4         |
| <b>3 Typical Application</b> .....   | <b>6</b>  |
| <b>4 Terminals and Interfaces</b> .....                                      | <b>7</b>  |
| 4.1 Terminals and Interfaces of DS-KH8301-WTS/ DS-KH8301-WT/DS-KH8300-T..... | 7         |
| 4.2 Terminals and Interfaces of DS-KH6310-W/ DS-KH6310.....                  | 8         |
| 4.3 Terminals and Interfaces of DS-KH6310-WL/ DS-KH6210-L.....               | 9         |
| <b>5 Installation and Wiring</b> .....                                       | <b>10</b> |
| 5.1 Indoor Station Installation.....   | 10        |
| 5.1.1 Wall Mounting Plate.....   | 10        |
| 5.1.2 Wall Mounting with Junction Box.....                                   | 10        |
| 5.2 Indoor Station Wiring.....   | 12        |
| 5.2.1 Wiring of DS-KH8301-WTS/ DS-KH8301-WT/DS-KH8300-T.....                 | 12        |
| 5.2.2 Wiring of DS-KH6310-W/DS-KH6310.....                                   | 13        |
| 5.2.3 Wiring of DS-KH6310-WL/DS-KH6210-L.....                                | 14        |
| <b>6 Before You Start</b> .....  | <b>16</b> |
| <b>7 Local Operation</b> .....   | <b>17</b> |
| 7.1 Activating Device Locally.....   | 17        |
| 7.2 User Interface Description.....  | 18        |
| 7.2.1 User Interface of Indoor Station.....                                  | 18        |
| 7.2.2 User Interface of Indoor Extension.....                                | 19        |
| 7.2.3 Status of Indoor Station.....  | 20        |
| 7.2.4 Status of Indoor Extension.....  | 21        |
| 7.2.5 Arming Status.....   | 22        |
| 7.3 Indoor Station Settings.....   | 23        |
| 7.3.1 Password Settings.....   | 23        |
| 7.3.2 Sound Settings.....  | 25        |
| 7.3.3 No Disturbing Settings.....  | 27        |
| 7.3.4 Zone Settings.....   | 28        |
| 7.3.5 Arming Mode Settings.....  | 29        |
| 7.3.6 System Maintenance.....  | 30        |

|  |            |
|--|------------|
| 7.3.7 Configuration Settings .....                               | 31         |
| 7.4 Call Settings .....  | 39         |
| 7.4.1 Adding Contact .....                                       | 39         |
| 7.4.2 Calling Resident .....                                     | 40         |
| 7.4.3 Calling Management Center .....                            | 41         |
| 7.4.4 Receiving Call .....                                       | 42         |
| 7.4.5 Viewing Call Logs .....                                    | 43         |
| 7.5 Live View .....  | 44         |
| 7.6 Information Management .....                                 | 46         |
| <b>8 Remote Operation via Batch Configuration Tool .....</b>     | <b>49</b>  |
| 8.1 Activating Device Remotely .....                             | 49         |
| 8.2 Editing Network Parameters .....                             | 50         |
| 8.3 Adding Device .....  | 51         |
| 8.3.1 Adding Online Device .....                                 | 51         |
| 8.3.2 Adding by IP Address .....                                 | 52         |
| 8.3.3 Adding by IP Segment .....                                 | 53         |
| 8.4 Configuring Devices Remotely .....                           | 54         |
| 8.4.1 System .....   | 54         |
| 8.4.2 Video Intercom .....                                       | 60         |
| 8.4.3 Network .....  | 65         |
| 8.5 Video Intercom Device Set-up Tool .....                      | 67         |
| 8.5.1 Setting a Community Structure .....                        | 67         |
| 8.5.2 Setting Indoor Station .....                               | 68         |
| 8.6 Batch Upgrading .....  | 69         |
| 8.6.1 Adding Devices for Upgrading .....                         | 69         |
| 8.6.2 Upgrading Devices .....                                    | 71         |
| <b>9 Remote Operation via iVMS-4200 .....</b>                    | <b>73</b>  |
| 9.1 System Configuration .....                                   | 73         |
| 9.2 Device Management .....                                      | 74         |
| 9.2.1 Adding Video Intercom Devices .....                        | 74         |
| 9.2.2 Modifying Network Information .....                        | 77         |
| 9.2.3 Resetting Password .....                                   | 77         |
| 9.3 Configuring Devices Remotely via iVMS-4200 .....             | 79         |
| 9.4 Picture Storage .....  | 80         |
| 9.4.1 Adding Storage Server .....                                | 80         |
| 9.4.2 Formatting the HDDs .....                                  | 81         |
| 9.4.3 Configuring Storage Server Picture Storage .....           | 82         |
| 9.5 Video Intercom Configuration .....                           | 83         |
| 9.5.1 Group Management .....                                     | 84         |
| 9.5.2 Video Intercom .....                                       | 89         |
| 9.5.3 Card Management .....                                      | 93         |
| 9.5.4 Notice Management .....                                    | 103        |
| 9.6 Device Arming Control .....                                  | 107        |
| <b>10 Accessing via Hik-Connect Mobile Client Software .....</b> | <b>109</b> |



|   |            |
|---|------------|
| 10.1 Installing Software .....            | 109        |
| 10.1.1 Installing Software (iOS) .....    | 109        |
| 10.1.2 Installing Software (Android)..... | 109        |
| 10.2 Registering Software.....            | 109        |
| 10.3 Logging in Software .....            | 112        |
| 10.4 Adding Device.....                   | 112        |
| 10.4.1 Adding Device via QR Code .....    | 112        |
| 10.4.2 Adding Device via Serial No.....   | 113        |
| 10.5 Live View and Remote Unlocking ..... | 114        |
| <b>Appendix .....</b>                     | <b>116</b> |
| Installation Notice .....                 | 116        |
| Wiring Cables .....                       | 116        |

# 1 Overview

---

## 1.1 Introduction

The video intercom system can realize functions such as video intercom, resident-to-resident video call, live view of HD video, access control, one-card system, elevator linkage, 8-ch zone alarm, notice information and visitor messages to provide a complete smart community video intercom system.

The video intercom indoor station is mainly applied to situations such as community, villa, and official buildings.

## 1.2 Main Features

- Video intercom function
- Remote unlocking function
- Resident-to-resident audio call
- Live view of HD video
- Voice message function
- Auto-respond and no disturbing mode
- Noise suppression and echo cancellation
- 8-ch zone alarm and SOS calling function
- Community notice
- Convenient installation with the bracket, batch settings, and power over video/audio distributor (DS-KAD606, DS-KAD612)

## 2 Appearance

### 2.1 Appearance of DS-KH8301-WTS/DS-KH8301-WT/ DS-KH8300-T

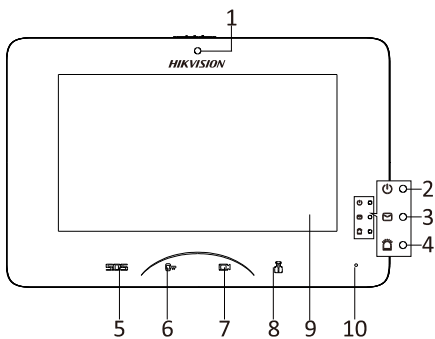

Figure 2-1 Front Panel

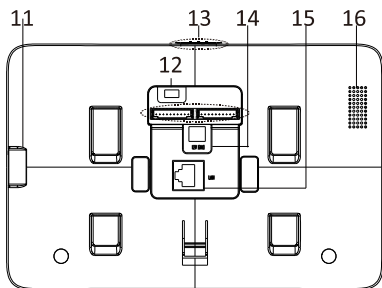

Figure 2-2 Rear Panel

Table 2-1 Components Description

| No. | Description                                  |
|-----|--|
| 1   | Built-in Camera (Only DS-KH8301-WT supports) |
| 2   | Power Supply Indicator                       |
| 3   | Information Indicator                        |
| 4   | Alarm Indicator                              |
| 5   | SOS Touch Key                                |
| 6   | Unlock Touch Key                             |
| 7   | Live View Touch Key                          |
| 8   | Management Center Touch Key                  |
| 9   | LCD Display Screen                           |
| 10  | Microphone                                   |

Table 2-2 Components Description

| No. | Description            |
|-----|------------------------|
| 11  | TF Card Slot           |
| 12  | Serial Port            |
| 13  | Mechanical Switch      |
| 14  | Power Supply Indicator |
| 15  | Network Interface      |
| 16  | Loudspeaker            |



- Hold down the **SOS** touch key to trigger a SOS alarm and upload the alarm message to the management center (iVMS-4200 client software or the master station).
- The Unlock key () is valid only when does the indoor station speak with the door station or open the live view of the door station.

## 2.2 Appearance of DS-KH6310-W/DS-KH6310

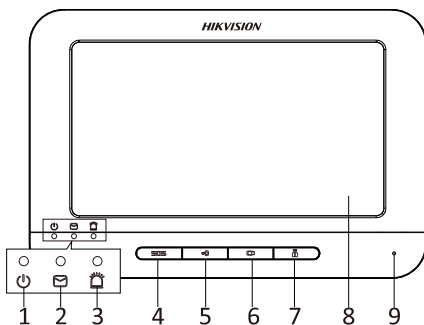

Figure 2-3 Front Panel

Table 2-3 Components Description

| No. | Description            |
|-----|------------------------|
| 1   | Power Supply Indicator |
| 2   | Information Indicator  |
| 3   | Alarm Indicator        |
| 4   | SOS Key                |
| 5   | Unlock Key             |
| 6   | Live View Key          |
| 7   | Management Center Key  |
| 8   | LCD Display Screen     |
| 9   | Microphone             |

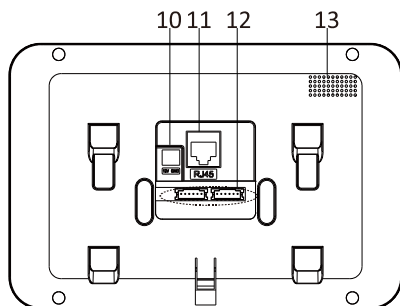



Figure 2-4 Rear Panel

Table 2-4 Components Description

| No. | Description            |
|-----|------------------------|
| 10  | Power Supply Interface |
| 11  | Network Interface      |
| 12  | Terminals              |
| 13  | Loudspeaker            |



- Hold down the **SOS** key to trigger a SOS alarm and upload the alarm message to the management center (iVMS-4200 client software or the master station).
- The Unlock key () is valid only when does the indoor station speak with the door station or open the live view of the door station.

## 2.3 Appearance of DS-KH6310-WL/DS-KH6210-L

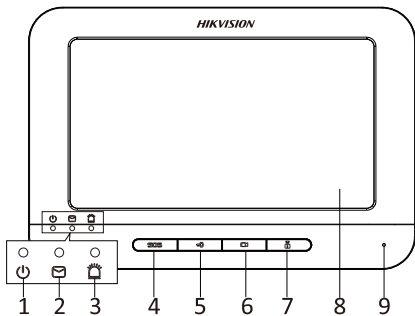

Figure 2-5 Front Panel

Table 2-5 Components Description

| No. | Description            |
|-----|------------------------|
| 1   | Power Supply Indicator |
| 2   | Information Indicator  |
| 3   | Alarm Indicator        |
| 4   | SOS Key                |
| 5   | Unlock Key             |
| 6   | Live View Key          |
| 7   | Management Center Key  |
| 8   | LCD Display Screen     |
| 9   | Microphone             |

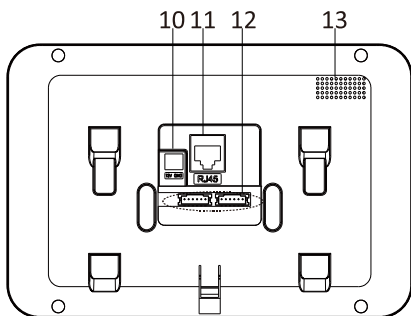





Figure 2-6 Rear Panel

Table 2-6 Components Description

| No. | Description       |
|-----|-------------------|
| 10  | Power Supply      |
| 11  | Network Interface |
| 12  | Terminals         |
| 13  | Loudspeaker       |



- Hold down the **SOS** key to trigger a SOS alarm and upload the alarm message to the management center (iVMS-4200 client software or the master station).
- The Unlock key (🔑) is valid only when does the indoor station speak with the door station or open the live view of the door station.
- For DS-KH6210-L indoor station, there are different meanings when you press or hold down the four mechanical keys.

| Keys  | Hold Down             | Press                             |
|---|-----------------------|-----------------------------------|
|  | SOS Key               | Return Key                        |
|  |                       | Direction Keys ▲ and ◀/Unlock Key |
|  | Live View Key Alarm   | Direction Keys ▼ and ▶            |
|  | Management Center Key | Confirm Key                       |

### 3 Typical Application

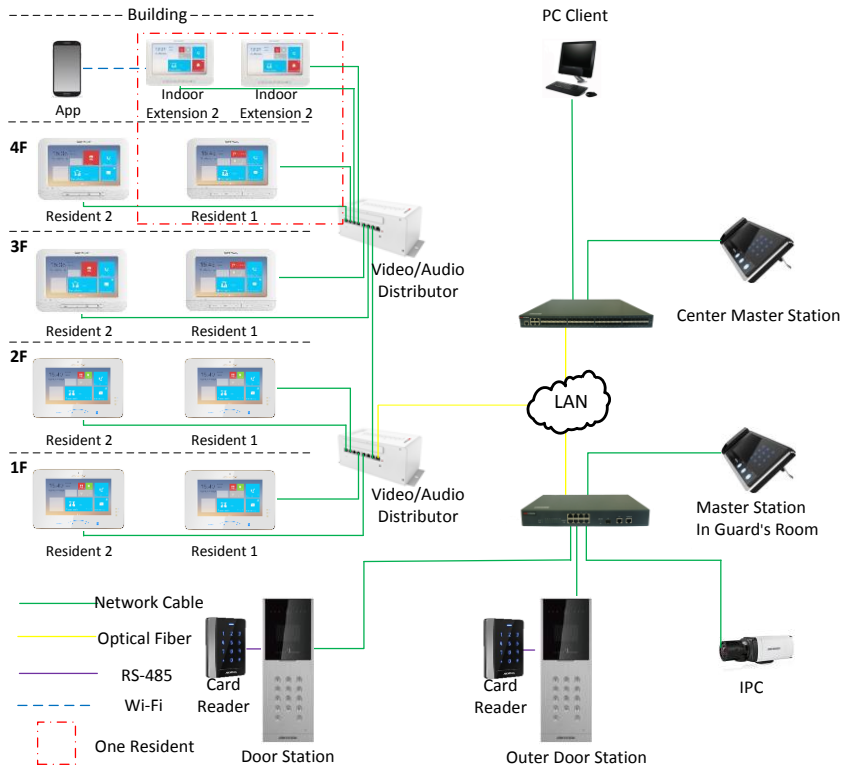

Figure 3-1 Typical Application of Indoor Station



Indoor extensions in a resident are in the same LAN with other devices in a video intercom system.

## 4 Terminals and Interfaces

### 4.1 Terminals and Interfaces of DS-KH8301-WTS/ DS-KH8301-WT/DS-KH8300-T

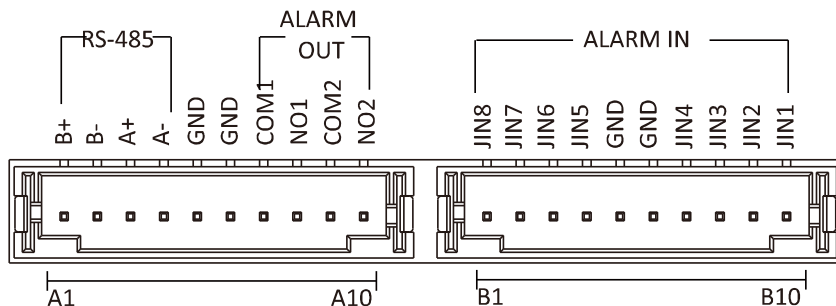

Figure 4-1 Terminals of DS-KH8301-WTS/DS-KH8301-WT/DS-KH8300-T

Table 4-1 Descriptions of Terminals and Interfaces

| Name                         | No. | Interface | Description                                 |
|------------------------------|-----|-----------|---|
| 485<br>Communication<br>Port | A1  | RS485B+   | Reserved                                    |
|                              | A2  | RS485B-   |   |
|                              | A3  | RS485A+   |   |
|                              | A4  | RS485A-   |   |
| Grounding                    | A5  | GND       | Grounding                                   |
|                              | A6  | GND       | Grounding                                   |
| ALARM OUT<br>(Alarm Output)  | A7  | COM1      | Alarm Relay Output Terminal 1 (Dry Contact) |
|                              | A8  | NO1       |   |
|                              | A9  | COM2      | Alarm Relay Output Terminal 2 (Dry Contact) |
|                              | A10 | NO2       |   |
| ALARM IN<br>(Zone Input)     | B1  | JIN8      | Zone Detector Input Terminal 8              |
|                              | B2  | JIN7      | Zone Detector Input Terminal 7              |
|                              | B3  | JIN6      | Zone Detector Input Terminal 6              |
|                              | B4  | JIN5      | Zone Detector Input Terminal 5              |
|                              | B5  | GND       | Grounding                                   |
|                              | B6  | GND       | Grounding                                   |



| Name | No. | Interface | Description                    |
|------|-----|-----------|--------------------------------|
|      | B7  | JIN4      | Zone Detector Input Terminal 4 |
|      | B8  | JIN3      | Zone Detector Input Terminal 3 |
|      | B9  | JIN2      | Zone Detector Input Terminal 2 |
|      | B10 | JIN1      | Zone Detector Input Terminal 1 |

## 4.2 Terminals and Interfaces of DS-KH6310-W/ DS-KH6310

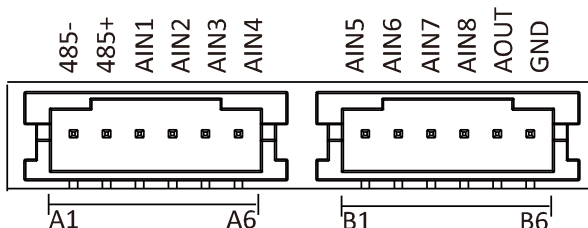

Figure 4-2 terminals of DS-KH6310-W/DS-KH6310

Table 4-2 Descriptions of Terminals and Interfaces

| Name      | No. | Interface | Description                    |
|-----------|-----|-----------|--------------------------------|
| Terminals | A1  | RS485-    | Reserved                       |
|           | A2  | RS485+    |                                |
|           | A3  | AIN1      | Zone Detector Input Terminal 1 |
|           | A4  | AIN2      | Zone Detector Input Terminal 2 |
|           | A5  | AIN3      | Zone Detector Input Terminal 3 |
|           | A6  | AIN4      | Zone Detector Input Terminal 4 |
|           | B1  | AIN5      | Zone Detector Input Terminal 5 |
|           | B2  | AIN6      | Zone Detector Input Terminal 6 |
|           | B3  | AIN7      | Zone Detector Input Terminal 7 |
|           | B4  | AIN8      | Zone Detector Input Terminal 8 |
|           | B5  | AOUT      | Alarm Relay Output             |
|           | B6  | GND       | Grounding                      |

### 4.3 Terminals and Interfaces of DS-KH6310-WL/ DS-KH6210-L

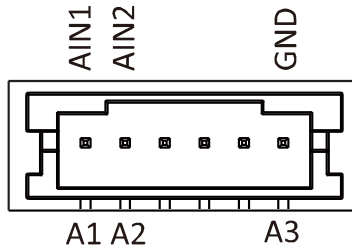

Figure 4-3 Terminals of DS-KH6310-WL/DS-KH6210-L

Table 4-3 Terminals Description

| Name      | No. | Interface | Description                    |
|-----------|-----|-----------|--------------------------------|
| Terminals | A1  | AIN1      | Zone Detector Input Terminal 1 |
|           | A2  | AIN2      | Zone Detector Input Terminal 2 |
|           | A3  | GND       | Grounding                      |

## 5 Installation and Wiring

### Before you start:

- Make sure the device in the package is in good condition and all the assembly parts are included.
- The power supply the indoor station supports is 12 VDC. Please make sure your power supply matches your indoor station.
- Make sure all the related equipment is power-off during the installation.
- Check the product specification for the installation environment.

### 5.1 Indoor Station Installation

The wall mounting plate and the junction box are required to install the indoor station onto the wall. Junction boxes for 8-series and 6-series indoor stations are the same.

#### 5.1.1 Wall Mounting Plate

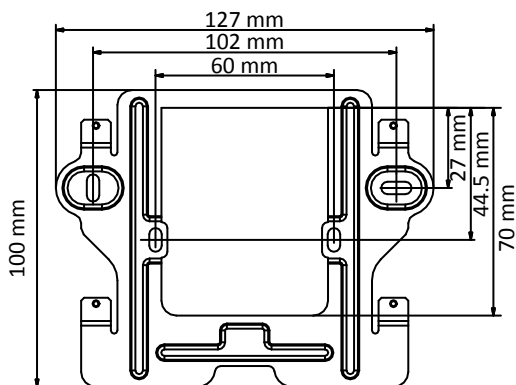

Figure 5-1 Wall Mounting Plate



The dimension of junction box should be 75 mm (width) × 75 mm (length) × 50 mm (depth).

#### 5.1.2 Wall Mounting with Junction Box

Wall mounting installations are the same for the 6-series indoor stations and the 8-series indoor stations. Here we take the wall mounting of DS-KH6310 model as an example.

**Steps:**

1. Chisel a hole in the wall. The size of the hole should be 76 mm (width) × 76 mm (length) × 50 mm (depth).
2. Insert the junction box to the hole chiseled on the wall.
3. Fix the wall mounting plate to the junction box with 2 screws.

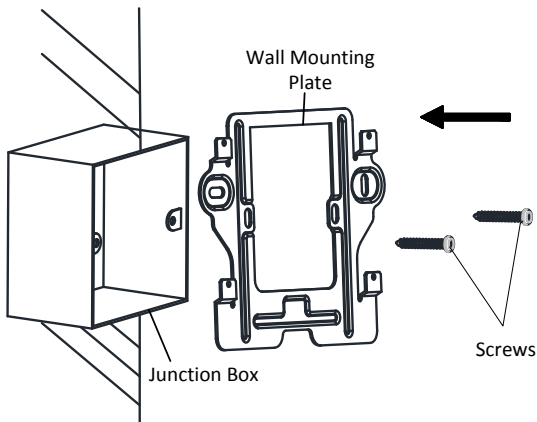

Figure 5-2 Install the Plate

4. Hook the indoor station to the wall mounting plate tightly by inserting the plate hooks into the slots on the rear panel of the indoor station, during which the lock catch will be locked automatically.

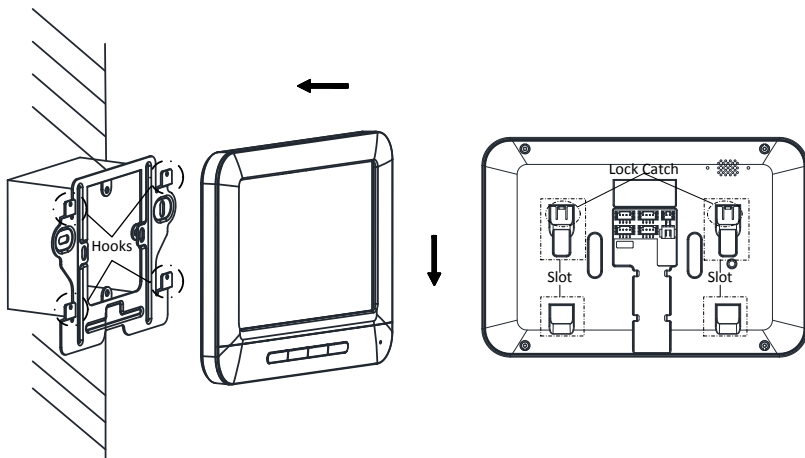

Figure 5-3 Hook the Indoor Station to the Plate

## 5.2 Indoor Station Wiring

### 5.2.1 Wiring of DS-KH8301-WTS/ DS-KH8301-WT/DS-KH8300-T

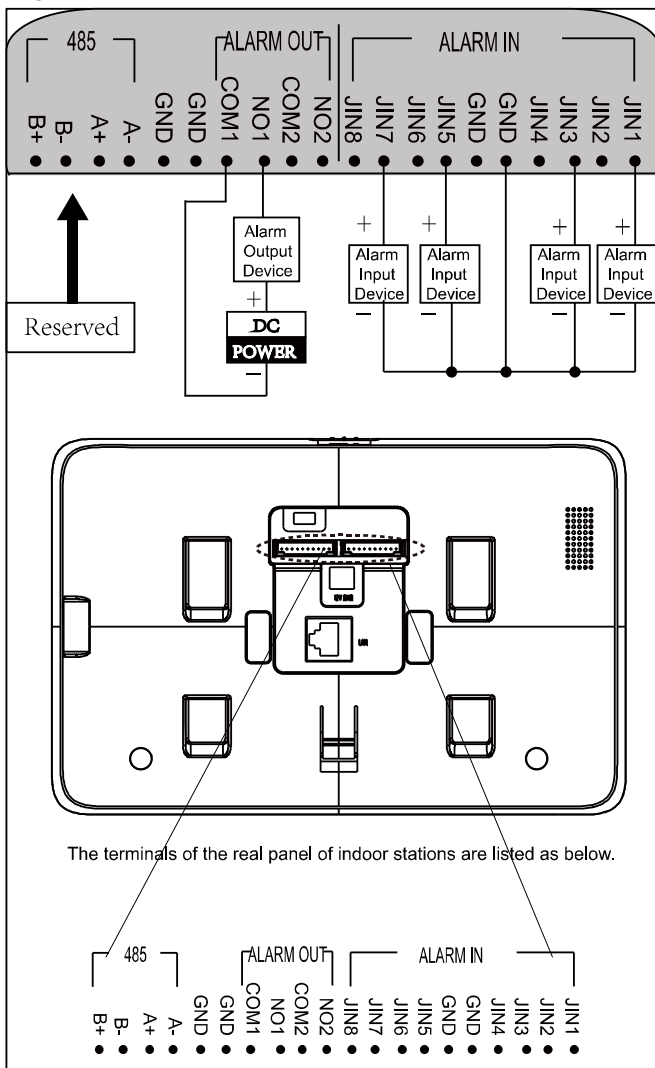

Figure 5-4 Wiring of DS-KH8301-WTS/DS-KH8301-WT/DS-KH8300-T Indoor Station

### 5.2.2 Wiring of DS-KH6310-W/DS-KH6310

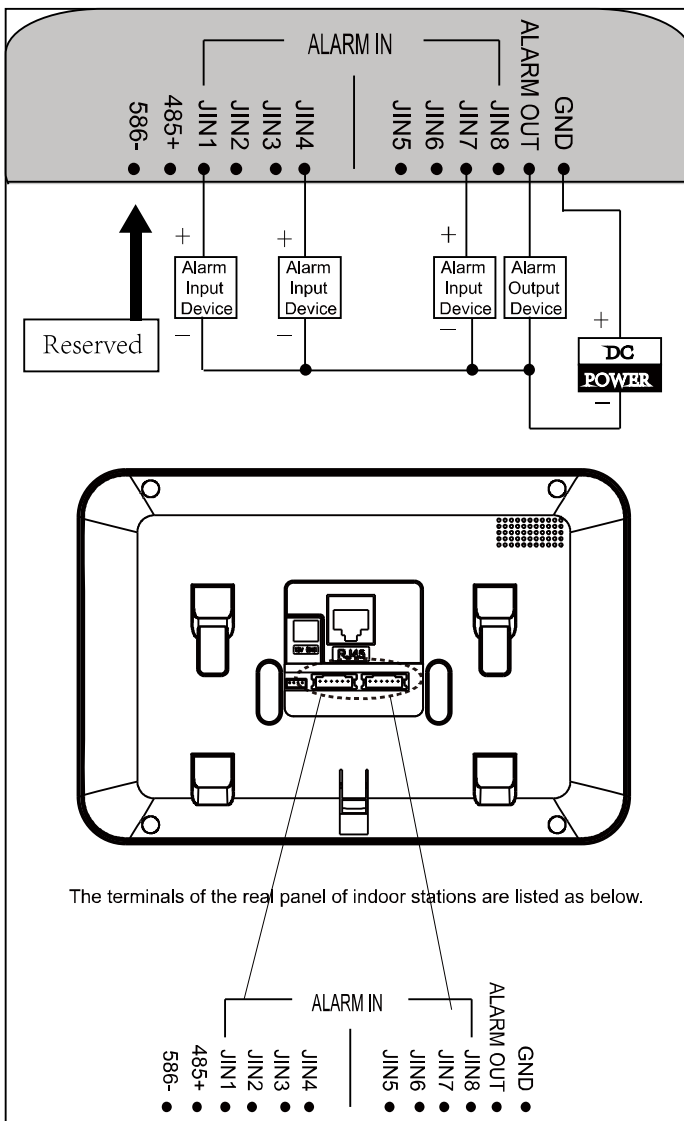

Figure 5-5 Wiring of DS-KH6310-W/DS-KH6310 Indoor Station

### 5.2.3 Wiring of DS-KH6310-WL/DS-KH6210-L

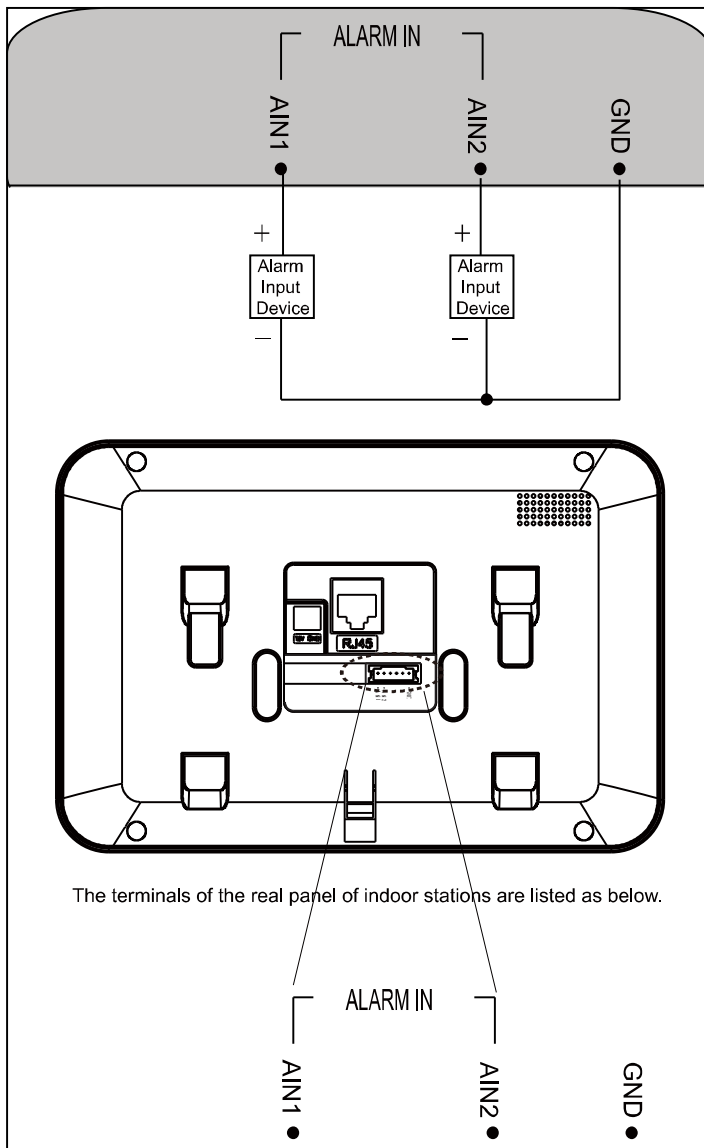

Figure 5-6 Wiring of DS-KH6310-WL/DS-KH6210-L Indoor Station



Descriptions of Indoor Station interfaces are shown in the following table.

| Interface | Description   |
|-----------|---|
| ALARM IN  | Connect alarm device, with one end of the device connecting to JINx and the other end connecting to GND (x indicates number between 1~8). |
| ALARM OUT | Connect alarm output devices.   |
| GND 12V   | Connect to DC power supply 12V.   |
| LAN       | Network port of indoor station. Connect the indoor station to the same LAN with the door station. (Support POE)                           |



## 6 Before You Start

---

For the first time use of the device, you are required to activate the device and set the device password. You can activate the device on the UI, via internet with Batch Configuration Tool, or with iVMS-4200 client software.



To activate the device on the UI, refer to *7 Local Operation*.

To activate the device with Batch Configuration Tool or iVMS-4200, refer to *8 Remote Operation via Batch Configuration Tool* and *9 Remote Operation via iVMS-4200*.

To configure the key parameters of device on the user interface of indoor station, you are required to input the admin password.

- The default admin configuration password is **888999**.
- The default unlocking password and arming/disarming password are **123456**;
- The default duress code is **654321**.

You must change these default credentials to protect against unauthorized access to the product.

## 7 Local Operation



- Here the local operation of indoor stations with touch screen is taken as example.
- The DS-KH6210-L should be operated with physical keys. The **SOS** key works as a return key; the **Unlock** key works as direction keys ▲ and ◀ to turn up and left; the **Live View** key works as direction keys ▼ and ▶ to turn down and right; and the **Management Center** key works as a confirm key.

### 7.1 Activating Device Locally

#### Steps:

1. Power on the device to enter the activation interface automatically.

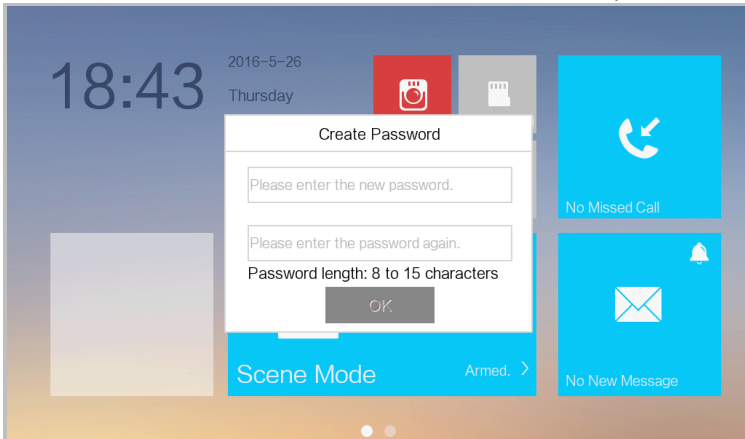

Figure 7-1 Activation Interface (DS-KH8301-WT)

2. Create a password and confirm it.
3. Press the **OK** button to activate the device.

**STRONG PASSWORD RECOMMENDED**– We highly recommend you to create a strong password of your own choosing (using a minimum of 8 characters, including at least three kinds of following categories: upper case letters, lower case letters, numbers, and special characters) in order to increase the security of your product. And we recommend you reset your password regularly, especially in the high security system, resetting the password monthly or weekly can better protect your product.



- You must create a password to activate the device for your first time usage and when it is not activated.
- Only when the device is activated, can you operate it locally and remotely.
- Here the activation interface of DS-KH8301-WT indoor station is taken as example.

## 7.2 User Interface Description

### 7.2.1 User Interface of Indoor Station

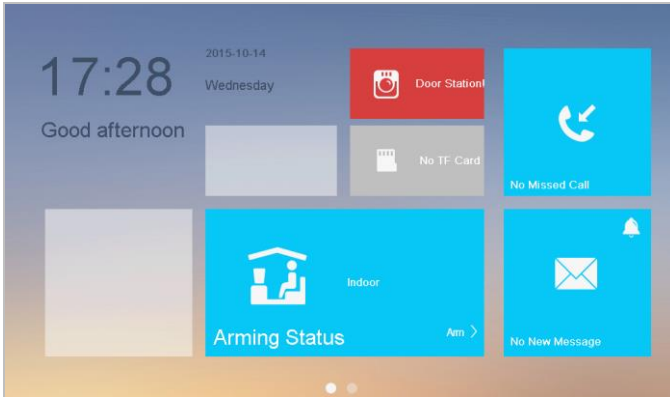

Figure 7-2 User Interface of Indoor Station (Page 1)

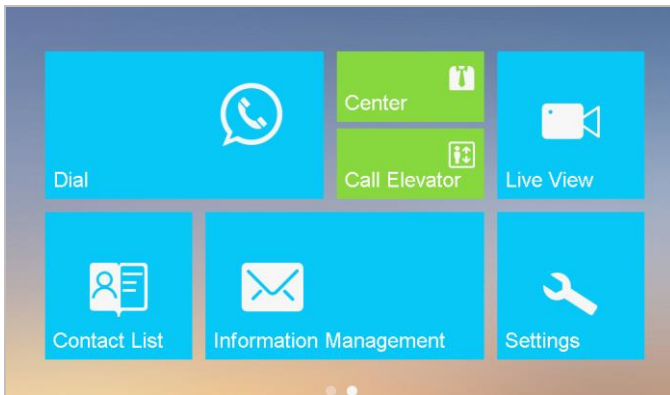

Figure 7-3 User Interface of Indoor Station (Page 2)



- Slide left and right to realize the switch between two interface pages (except for DS-KH6210-L).
- Here the user interface of DS-KH8301-WT is taken as an example.
- Only DS-KH8301-WTS/DS-KH8301-WT/DS-KH8300-T indoor stations support TF card.
- DS-KH6210-L only has one interface page.

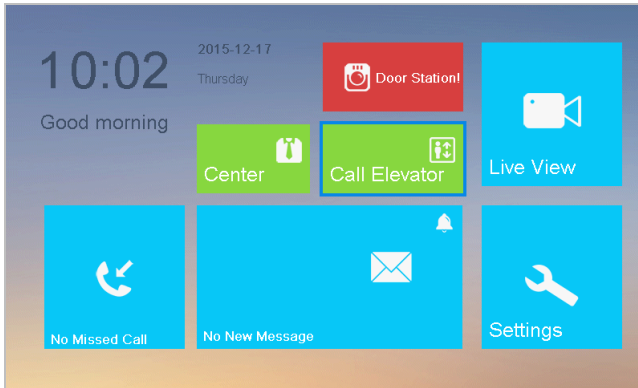

Figure 7-4 User Interface of DS-KH6210-L

## 7.2.2 User Interface of Indoor Extension

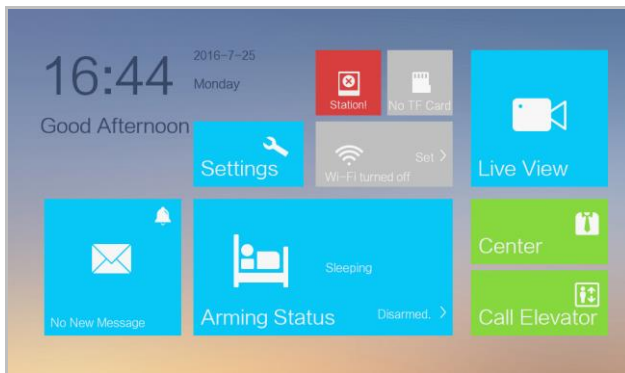







Figure 7-5 User Interface of Indoor Extension





- Only DS-KH8301-WTS/DS-KH8301-WT/DS-KH8300-T indoor extensions support TF card.
- Here the user interface of DS-KH8301-WT indoor extension is taken as an example.

## 7.2.3 Status of Indoor Station







Table 7-1 Description of Status Icons

| Icon  | Definition   | Description   |
|---|--|---|
|    | Normal Status.   | The communication between indoor station, door station and master station is normal. And the communication between indoor station and indoor extension is normal. |
|    | The indoor station is offline.                                     | Please check the network cable or Wi-Fi connection.   |
|    | Exception occurs in the communication with door station.           | Room No. conflict. Configure the Room No. again.  |
|   |  | Invalid Room No.. Configure the Room No..   |
|   |  | Invalid main door station IP address. Configure the main door station IP address.   |
|   |  | Network of door station is abnormal. Check the network connection of main door station.   |
|   | The indoor station has not registered in the SIP server.           | Communication of door station is abnormal. Check if the door station IP address is correct.   |
|   |  | Invalid SIP server IP address. Set the SIP server IP address.   |
|   |  | Network of SIP server is not available. Check the SIP server network connection.  |
|   |  | SIP server communication is not available. Check if the SIP server IP address is correct.   |
|  | The indoor station IP address conflicts with that of other device. | SIP server rejected to login the device. Check if the device No. has been registered.   |
|   |  | Please check the IP address.  |
|  | TF card is inserted in the indoor station.                         | Only DS-KH8301-WTS/DS-KH8301-WT/DS-KH8300-T Models support the TF card function.  |

| Icon  | Definition                                    | Description |
|---|---|-------------|
|  | Exception occurs with the TF card.            |             |
|  | No TF card is inserted in the indoor station. |             |

## 7.2.4 Status of Indoor Extension

Table 7-2 Description of Status Icons

| Icon  | Definition   | Description  |
|---|--|--|
|    | Normal Status.   | The communication between indoor station and indoor extension is normal.                 |
|    | The indoor extension is offline.                                     | Please check the network cable or Wi-Fi connection.                                      |
|    | The indoor extension IP address conflicts with that of other device. | Please check the IP address.   |
|   | The indoor extension has not connected to the indoor station.        | Invalid indoor station IP address. Set the indoor station IP address.                    |
|   |  | Network of indoor station is not available. Check the indoor station network connection. |
|   |  | The indoor extension number conflicts with number of another indoor extension.           |
|  | TF card is inserted in the indoor station.                           | Only DS-KH8301-WTS/DS-KH8301-WT/DS-KH8300-T Models support the TF card function.         |
|  | Exception occurs with the TF card.                                   |  |
|  | No TF card is inserted in the indoor station.                        |  |

## 7.2.5 Arming Status

### **Purpose:**

4 kinds of scene modes are supported by the indoor station: Sleeping Mode, Indoor Mode, Outdoor Mode, and Custom Mode.

You can arm or disarm your room in each scene mode manually. When your room is in the arming status, the arming status will display on the main interface of the indoor station.

### **Arming Your Room**

#### **Steps:**

1. Press the **Arming Status** tab to display the arming status interface.

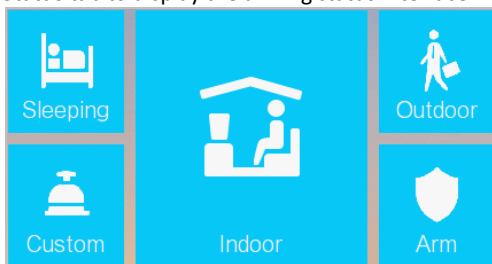

Figure 9-1 Pressing Arm Tab

2. Press the **Arm** tab.
3. Enter the arm password to enable the arming status.
4. (Optional) Press a scene mode icon, and enter the arm password to change the scene mode of the indoor station.

**Example:** After setting the arming status, press the Sleeping tab, and enter the arm password. The indoor station changes to the arming status of the sleeping mode and the interface will display as follow:

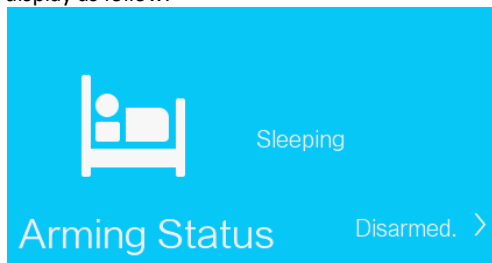

Figure 9-2 Sleeping Mode

### **Disarming Your Room**

1. Press the **Arming Status** tab to display the arming status interface.

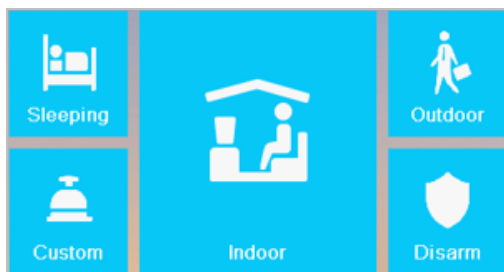

Figure 9-3 Pressing Disarm Tab

2. Press the **Disarm** tab.
3. Enter the disarm password to enable the disarming status.
4. (Optional) Press a scene mode icon, and enter the disarm password to change the scene mode of the indoor station.



- Only one mode of arming can be set at one time. When you set another mode of arming status, the former one is disarmed automatically.
- If enabling the arming status successfully, you can hear a voice prompt “armed”, and the corresponding arming status will display on the main interface.
- If enabling the disarming status successfully, you can hear a voice prompt “disarmed”, and the corresponding disarming status will display on the main interface.
- The DS-KH6210-L indoor station does not support this function.

## 7.3 Indoor Station Settings

### ***Purpose:***

On the settings interface, you can set passwords (admin password, duress code, unlock password, and arm/disarm password), set the device sound, set no disturbing schedule, set the arming mode and zone, perform the system maintenance, set the configuration settings, and view the device information.

### 7.3.1 Password Settings

#### ***Purpose:***

- You can edit the admin password (configuration password), duress code, unlock password and arm/disarm password of the indoor station.
- You can edit the admin password (configuration password) and arm/disarm password of the indoor extension.
- Enter admin password when configuring key parameters.



- Enter duress code in the door station when the user is hijacked.
- Enter unlock password in the door station when opening door of the building.
- Enter arm/disarm password when arming/disarming the zone.

**Steps:**

1. Press the **Settings** tab on the touch screen to enter the password settings interface.

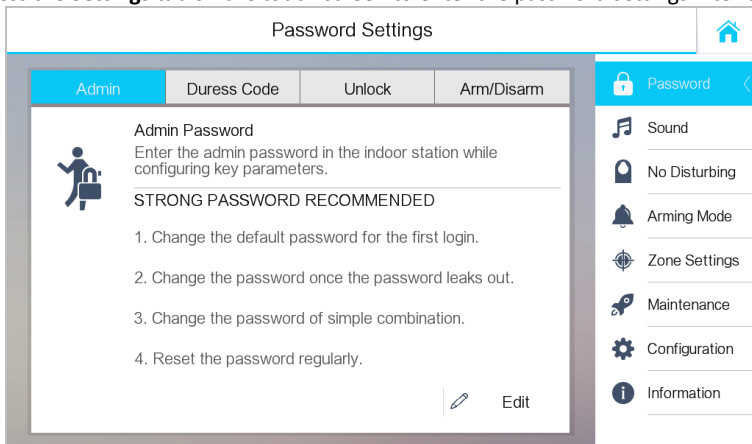

Figure 9-4 Password Settings Interface (Indoor Station)

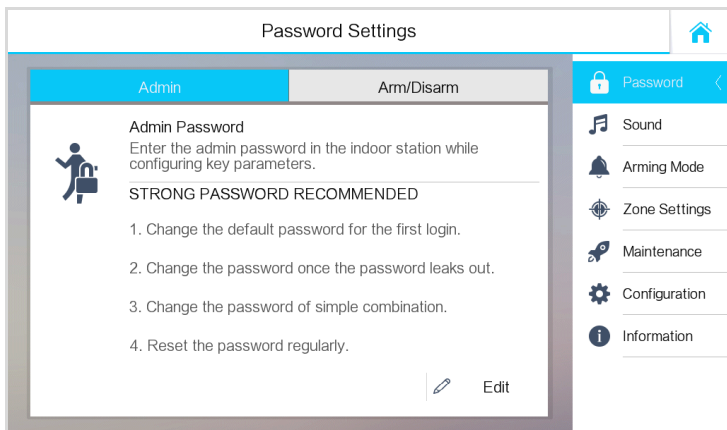



Figure 9-5 Password Settings Interface (Indoor Extension)

2. Press the **Admin Password** tab, **Duress Code** tab, **Unlock Password** tab, or **Arm/Disarm Password** tab to enter corresponding interfaces.
3. Press the **Edit** tab to pop up the password changing dialogue box.



Figure 9-6 Password Changing Interface

4. Enter the old password to change it
5. Enter the new password and confirm it.
6. Press the  tab to save the settings.

**STRONG PASSWORD RECOMMENDED**– We highly recommend you to create a strong password of your own choosing (using a minimum of 8 characters, including at least three kinds of following categories: upper case letters, lower case letters, numbers, and special characters) in order to increase the security of your product. And we recommend you reset your password regularly, especially in the high security system, resetting the password monthly or weekly can better protect your product.



- The default admin password (configuration password) is **888999**.
- The default unlock password, arm/disarm password, and scene password are **123456**.
- The default duress code is **654321**.
- For Indoor Extension, only admin password and arm/disarm password are supported.

### 7.3.2 Sound Settings

#### **Purpose:**

You can set the ringtone, ring duration, call forwarding time, volume of microphone and loudspeaker, enable/disable touch sound and auto-answer function on sound settings interface.

#### **Steps:**

1. Get to the sound settings interface: **Settings -> Sound Settings**.

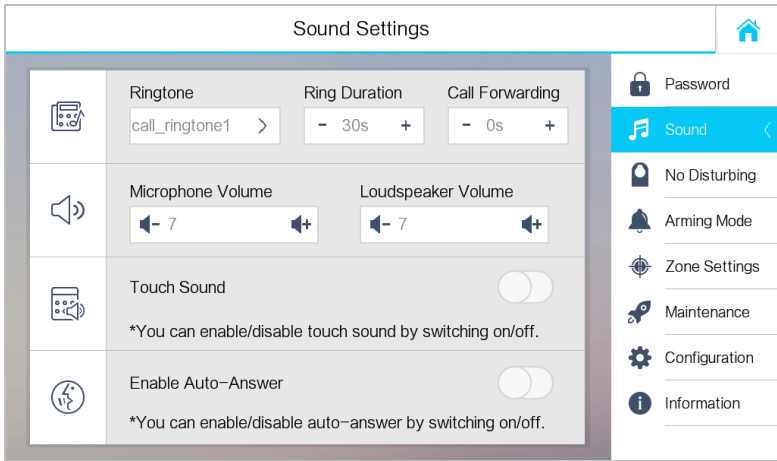

Figure 9-7 Sound Settings Interface (Indoor Station)

2. Set corresponding parameters.

**Ringtone:** There are 3 ringtones by default, and you can custom and import at most 4 ringtones via Batch Configuration Tool or iVMS-4200 Client Software.

**Ring Duration:** The maximum duration of indoor station when it is called without being accepted. Ring duration ranges from 30s to 60s.

**Call Forwarding (Time):** The ring duration limit beyond which the call is automatically forwarded to eh mobile phone designated by the resident. Call forwarding (time) ranges from 0s to 20s.

**Enable Auto-Answer:** After enabling the auto-answer function, the visitor can leave the voice message to the indoor station from the door station, the master station, or the client software.



- Auto-answer function is only available to 8-series indoor stations with TF card function and 6-series indoor stations.
- For indoor extension, it does not support the ring duration settings, call forwarding settings, or auto-answer function.

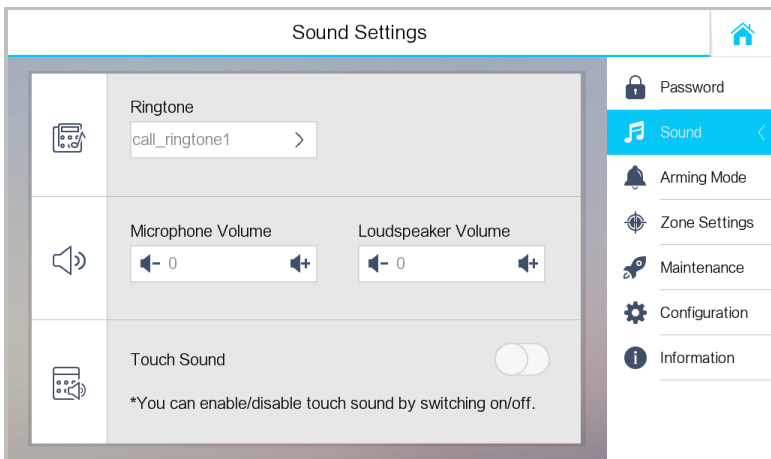

Figure 9-8 Sound Settings Interface (Indoor Extension)

### 7.3.3 No Disturbing Settings

**Purpose:**

Two types of no disturbing mode can be configured: **All day** and **Scheduled**.

**Steps:**

1. Get to the no disturbing settings interface: **Settings -> No Disturbing**.

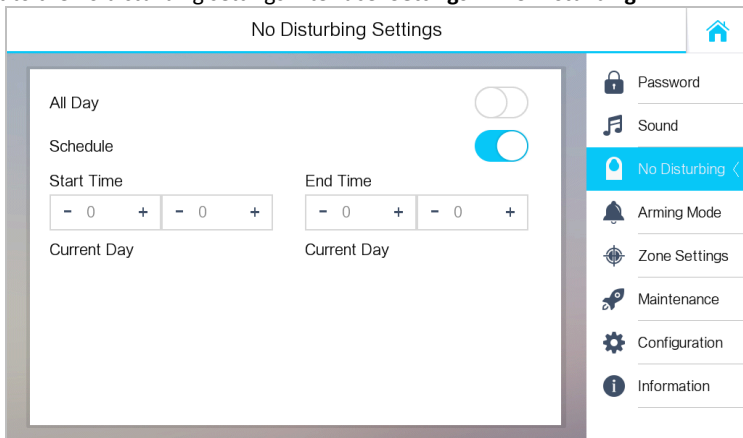





Figure 9-9 No Disturbing Settings Interface

2. Select no disturbing mode: **All Day** or **Scheduled**.

- **All Day:**

- 1) Switch  to  to enable no disturbing mode.
- **Scheduled:**
- 1) Switch  to  to enable no disturbing mode.
- 2) Set the start time and the end time.



- Under all-day no disturbing mode, the indoor station will not ring all day when it is called by door station or other indoor stations, but the call logs will be saved.
- Under scheduled no disturbing mode, the indoor station will not ring between the start time and the end time when it is called by door station or other indoor stations, but the call logs will be saved.
- Indoor extension does not support No Disturbing Settings.

### 7.3.4 Zone Settings

**Purpose:**

You can set the zone type, alarm type and delay time and other parameters of 8 zones.

**Steps:**

1. Get the zone settings interface: **Settings -> Zone Settings.**

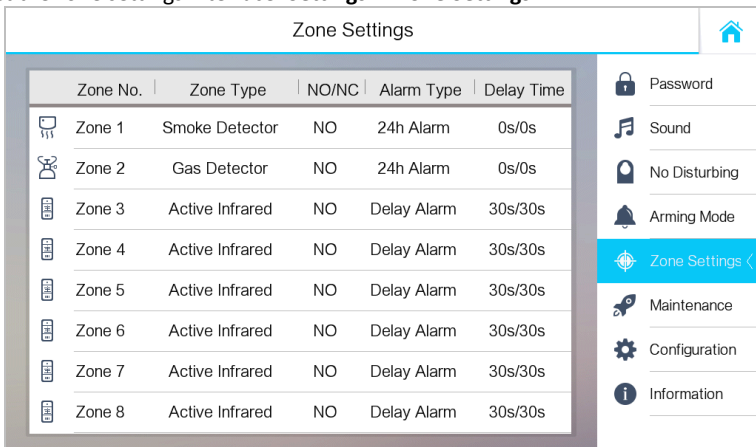



Figure 9-10 Zone Settings Interface

2. Press a zone to pop up the zone editing dialogue box.

| Setting     | Value          |
|-------------|----------------|
| Zone Type   | Smoke Detector |
| Alarm Type  | 24h Alarm      |
| NO/NC       | NO             |
| Enter Delay | - 0s           |
| Exit Delay  | - 0s           |

Figure 9-11 Zone Editing Interface

- Set the zone type, alarm type, status of arming status, entering delay, and exiting delay.
- Press the  tab to save the settings.



- 6 zone types are selectable: Panic Button, Door Magnetic, Smoke Detector, Active Infrared, Passive Infrared, and Gas Detector.
- 3 alarm types are selectable: 24h Alarm, Instant Alarm, and Delay Alarm.
  - Set the alarm type as 24h alarm, and the zone will be armed for 24h.
  - Set the alarm type as instant alarm, and the zone will alarm once it's triggered.
  - Set the alarm type as delay alarm, and you should set the entering delay duration and exiting delay duration.
- Both the entering delay duration and the exiting delay duration are from 30s to 60s.
- For Gas Detector and Smoke Detector, the alarm type is set as default 24h alarm.
- The DS-KH6210-L and DS-KH6310-WL indoor stations only support 2 zones.

### 7.3.5 Arming Mode Settings

#### **Purpose:**

4 arming modes can be configured: outdoor mode, indoor mode, sleeping mode and custom mode.

#### **Steps:**

- Get to the arming mode settings interface: **Settings -> Arming Mode**

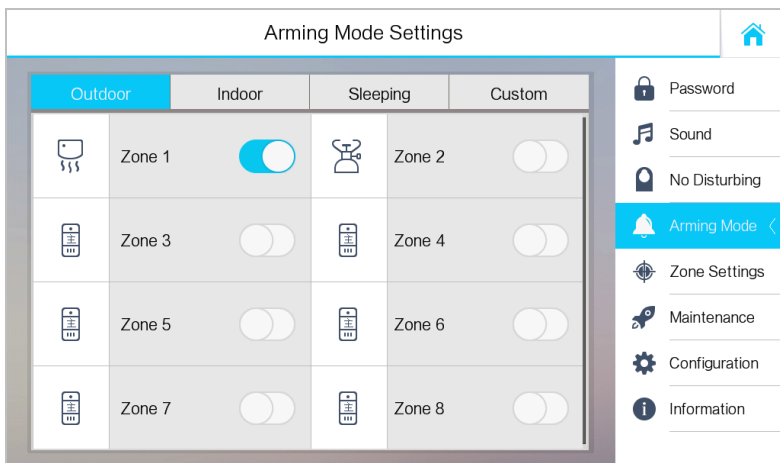



Figure 9-12 Arming Mode Settings Interface

2. Press **Outdoor Mode** tab, **Indoor Mode** tab, **Sleeping Mode** tab, and **Custom Mode** tab to enter corresponding arming mode settings interface.
3. Switch  to  to enable the arming in the selected zoon.





- Zones in each arming mode can be configured manually. See detailed information in *7.3.4 Zone Settings*.
- For 24H alarm zone and smoke detector zone, even if it is disabled under current arming mode, the indoor station will still alarm when it is triggered.
- Arming mode settings should be configured with the settings of arming status on the the user interface of the device.
- The DS-KH6210-L and DS-KH6310-WL indoor stations only support 2 zones.

### 7.3.6 System Maintenance

#### **Purpose:**

You can format TF card, clear the screen, view the version information of the indoor station and reboot the system on the system maintenance interface.

#### **Steps:**

1. Get to the system maintenance interface: **Settings** -> **Maintenance**.
2. Press the **Format** tab to format the TF card.
3. Switch  to  to enable the clear screen mode.

4. Press the **Reboot** tab to reboot the system.

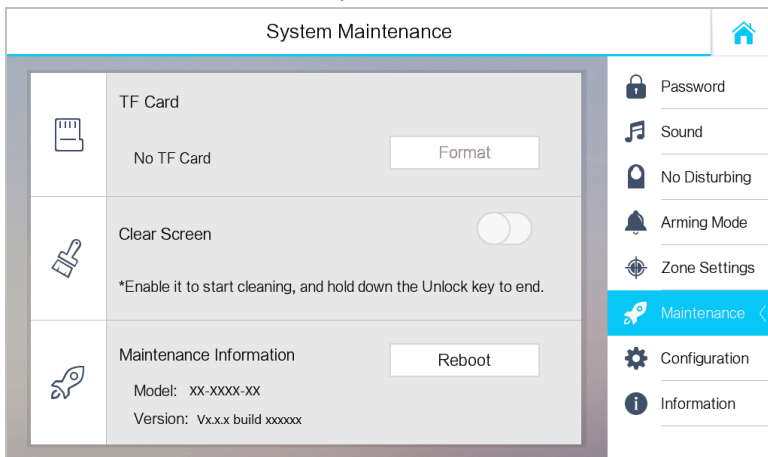



Figure 9-13 System Maintenance Interface



- Only DS-KH8301-WTS/DS-KH8300-T/DS-KH8301-WT indoor stations support TF card function.
- After enabling Clear Screen function, press and hold the **Unlock** key () to exit the clear screen mode.

### 7.3.7 Configuration Settings

**Purpose:**

On the configuration settings interface, you can set and view the local information, configure the network, manage devices, synchronize the device time, and restore the default settings.

#### Setting Local Information

**Steps:**

1. Get to the configuration interface: **Settings > Configuration**, and enter the admin password (configuration password).
2. Press the **Local Info** tab, and select the indoor station type: **Indoor Station**, or **Indoor Extension**.
  - Indoor Station:** Set the Room No.
  - Indoor Extension:** Set the Extension No., and set a room name.



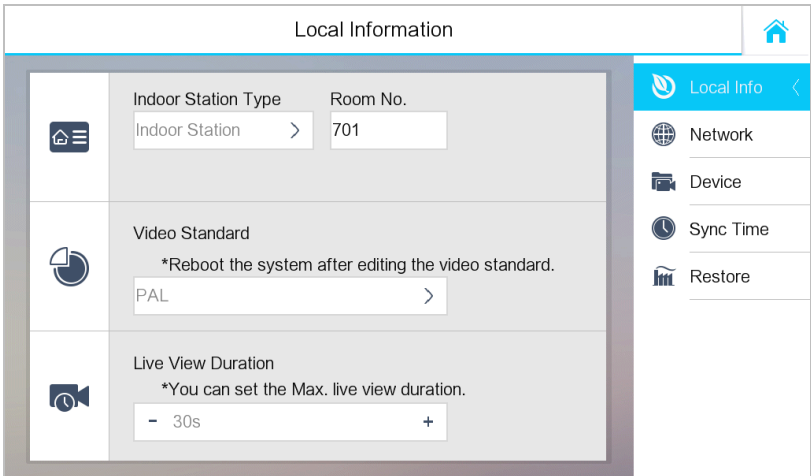

Figure 7-6 Local Information Settings (Indoor Station)

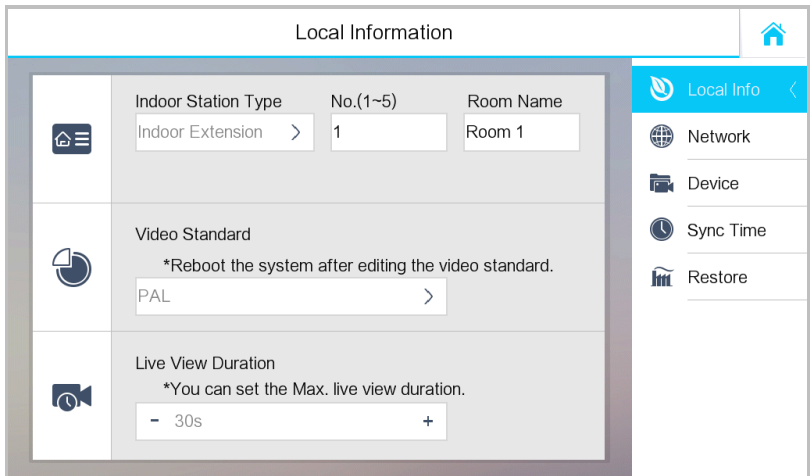

Figure 7-7 Local Information Settings (Indoor Extension)

3. Press the drop-down list to select a video standard: **PAL**, or **NTSC**.
4. Set the maximum live view duration of the device.



- The Extension No. is numeric from 1 to 5, i.e., up to 5 indoor extensions can connect to one indoor station.

- Only DS-KH8301-WT, and DS-KH8301-WTS require setting the video standard, and the system will reboot after selecting video standard.
- The maximum live view duration varies from 10 seconds to 60 seconds.

## Setting Network

### Purpose:

Network connection is mandatory for the use of the indoor station.

### Steps:

1. Get to the configuration interface: **Settings > Configuration**, and enter the admin password (configuration password).
2. Press the **Network** tab to enter the network settings interface.

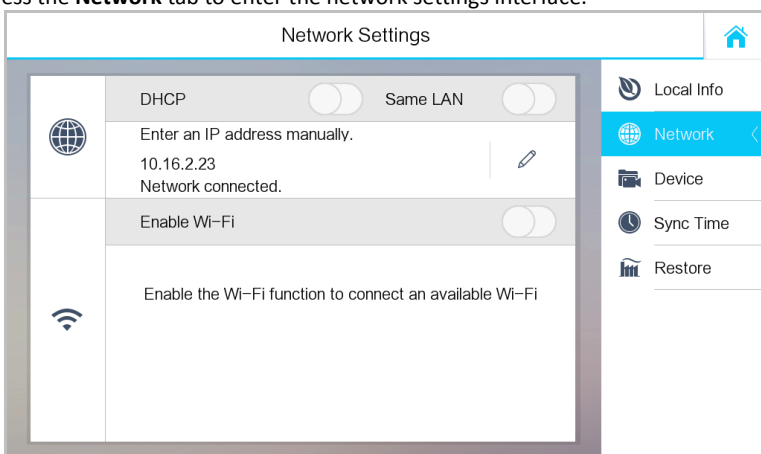



Figure 7-8 Network Interface

3. Press the  tab to pop up network settings dialogue box.

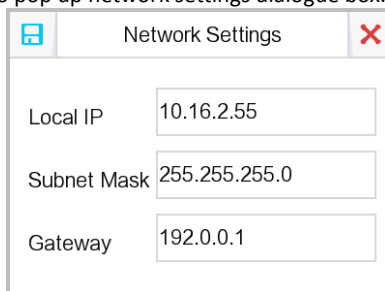



Figure 7-9 Setting Network

4. Enter a local IP address, subnet mask, and gateway.
5. Press the  tab to save the settings.



- Enable **DHCP** function to obtain an IP address automatically.
- Enable **Same LAN** function if indoor stations and indoor extensions are in the same local area network with other video intercom devices in a community, or the indoor extensions will not work normally.

## Setting the SIP Server

### *Purpose:*

To realize the connection between the indoor station and the management center (master station), the indoor station should connect to a SIP server in advance.

### *Steps:*

1. Get to the device management interface: **Settings -> Configuration -> Device**.
2. Press the **SIP Server** tab, and enter the IP address of the SIP server.
3. Press the  tab to save the SIP server added.



- The master station can work as a SIP server.
- Indoor extension cannot connect to the SIP server.

## Adding Devices

### *Purpose:*

The indoor station never works alone. You can connect the main door station, IP camera, SIP server, management center, master station, DVR/DVS/NVR, and so on. Once connected, those devices can work together as a whole video intercom system.



- The DS-KH6210-L indoor station does not support adding IP camera, DVR/DVS/NVR, or doorphone.
- Indoor Extension only supports adding indoor station.
- **Setting Center/Master Station (Optional)**

### *Steps:*

1. Get to the device interface: **Settings -> Configuration -> Device**.
2. Press the **Center** or **Master Station** tab to pop up the device information dialogue box.



Figure 7-10 Center/Master Station Adding Interface (Indoor Station)

3. Entering the IP address of center or the master station, and press the  tab to save the settings.



- After setting center or the master station in the indoor station, the alarm messages will be uploaded to the center or the master station automatically.
- You can edit but not delete the center or the master station in the device management interface.

- **Connecting Main Door Station**

**Steps:**

1. Get to the device interface: **Settings -> Configuration -> Device.**
2. Press the **Main Door Station** tab to pop up the device information dialogue box.

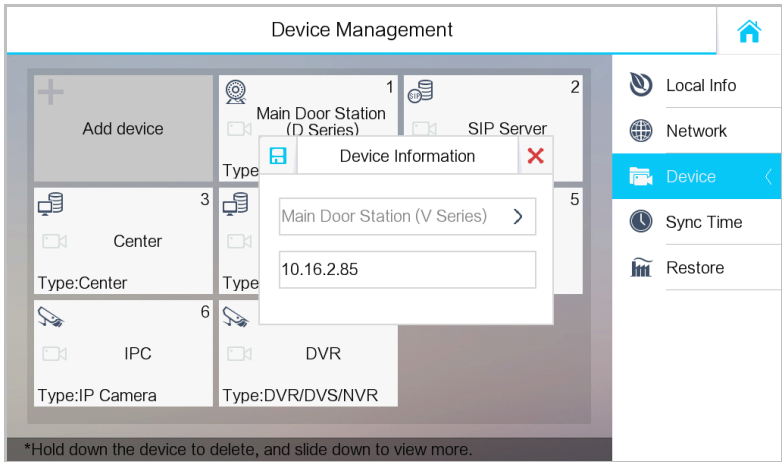



Figure 7-11 Main Door Station Adding Interface (Indoor Station)

3. Select the main door station type: D Series, or V Series.
4. Enter the IP address of the main door station, and press the  tab to save the settings.



You can edit but not delete the main door station in the device management interface.

### ● Adding IP Camera/DVR/DVS/NVR/Doorphone

#### **Steps:**

1. Get to the device management interface: **Settings -> Configuration -> Device.**
2. Press the **Add Device** tab.

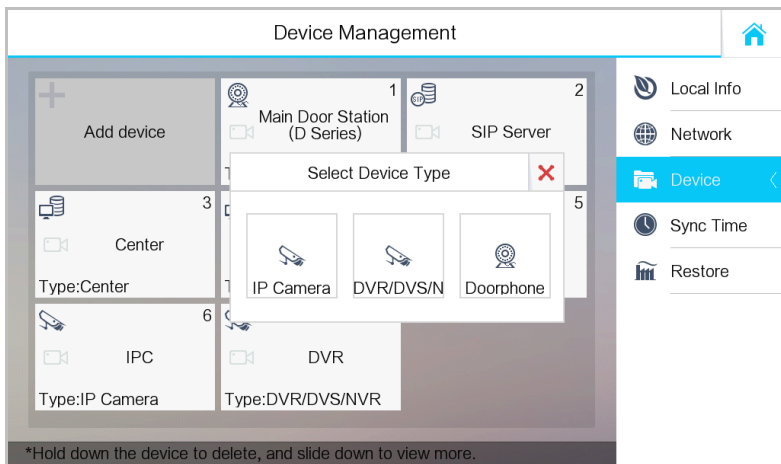



Figure 7-12 Device Selecting Interface (Indoor Station)

3. Select a kind of device type, and enter corresponding information (device name, IP address, port No., password, etc.).
4. Press the  tab to save the settings.



- The default port No. is 554, and the default user name is admin.
- Up to 8 doorphones can be added to the indoor station.
- Up to 16 IP cameras and DVR/DVS/NVR in total can be added to the indoor station.
- When the IP camera is added successfully, you can get the live view of IP camera on the live view interface.
- The highest resolution of the IP camera added to the indoor station is 1280 x 720 @ 30 fps, and the video compression standard of the IP camera should be H.264.

## Synchronizing Time

### Steps:

1. Get to the time synchronizing interface: **Settings -> Configuration -> Sync Time.**

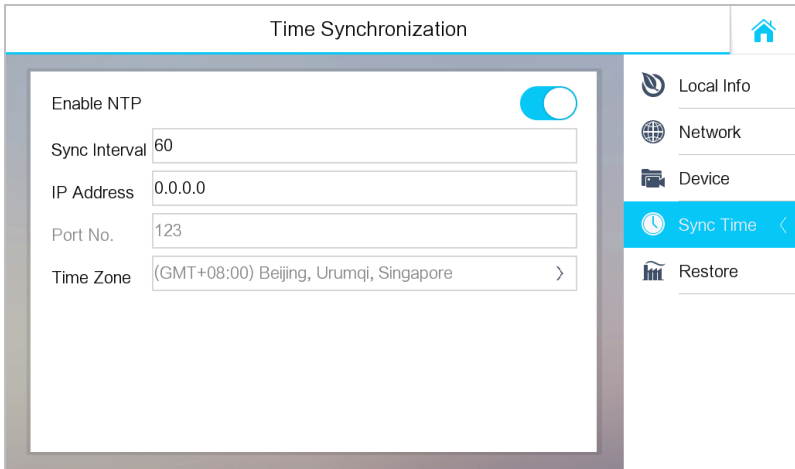



Figure 9-14 Time Synchronizing Interface

2. Switch  to  to enable NTP.
3. Set the synchronizing interval, enter the IP address of NTP server and port No., and select the time zone.



- The default unit of synchronizing interval is minute.
- The default port No. is 123.

## Restoring and Upgrading Device

### Steps:

1. Get to the device restoring and upgrading interface: **Settings -> Configuration -> Restore.**
2. Press the **RESTORE** button to restore the default settings and reboot the system.
3. Press the **UPGRADE** button to upgrade the indoor station online.

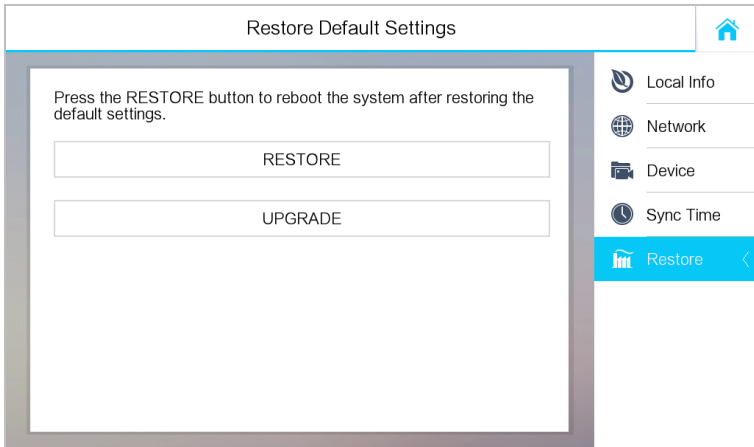

Figure 9-15 Device Restoring and Upgrading



Only DS-KH8301-WTS/DS-KH8301-WT/DS-KH6310-W/DS-KH6310-W(T) indoor stations support online upgrading.

## 7.4 Call Settings

### 7.4.1 Adding Contact

**Steps:**



1. Press the **Contact List** tab on the user interface to enter the contact list interface.



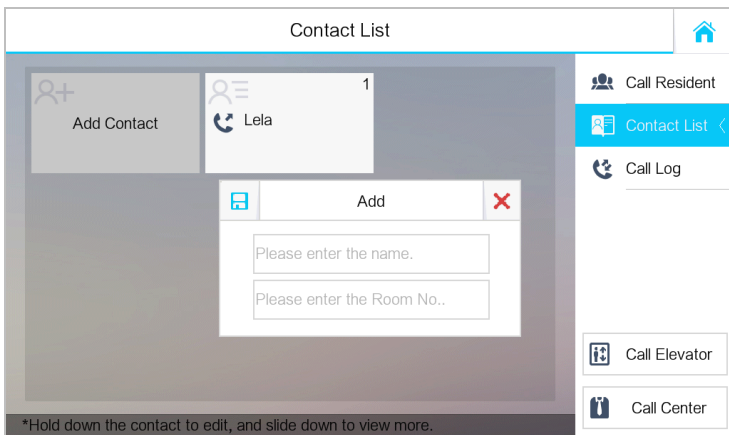

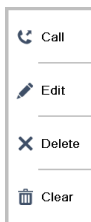

Figure 9-16 Contact List Interface

2. Press the **Add Contact** tab to pop up the contact adding dialogue box.
3. Enter the name and room number of the contact.
4. Press the  tab to save the settings.



- Hold down an added contact to open the contact handling menu.





- Press the **Call** tab to start the video call with the contact.
- Press the **Edit** tab to modify the contact information.
- Press the **Delete** tab to delete the contact.
- Press the **Clear** tab to delete all contacts added in the indoor station.
- Indoor extension does not support this function.
- The DS-KH6210-L does not support this function.



### 7.4.2 Calling Resident

**Steps:**



1. Press the  tab on the touch screen to enter the residents calling interface.
2. Enter the corresponding resident's Room No..
3. Press the  tab to start an audiovisual call.
4. Press the  tab to stop the audiovisual call.



- Generally speaking, Room No. format should be like 1-2-3-405 as Community 1, Building 2, Unit 3, and Room 405. The community No. can be omitted.
- Switch  to  on the upper right corner to enable the camera function.
- The Room No. can be automatically saved into the contact list.
- Indoor extension does not support this function.
- On the call resident interface of DS-KH6210-L, there is no **Contact List**, **Call Elevator**, or **Call Center** tab.

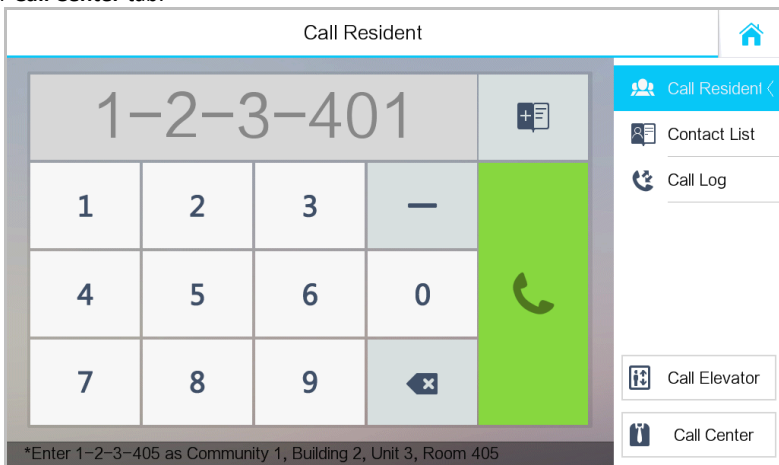



Figure 7-13 Call Resident Interface

### 7.4.3 Calling Management Center

2 options are selectable to call management center.

**Option 1:**



Press the tab  on the main interface of the indoor station.

**Option 2:**

Press the tab  Call Center on the speaking interface or the live view interface.



- Management center here refers to the master station and iVMS-4200 client software.
- For indoor extension, it only supports calling the master station.

### 7.4.4 Receiving Call

**Purpose:**

The indoor station can receive calls from the door station, the master station, or iVMS-4200 client software.

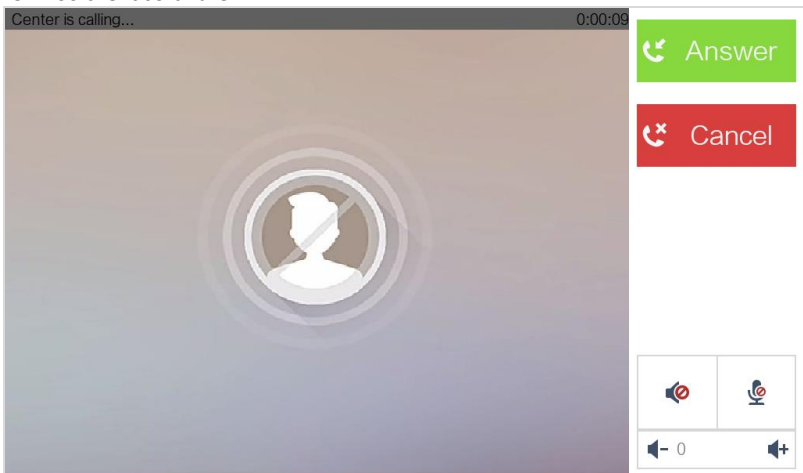



Figure 9-17 Call from Center (Master Station or iVMS-4200)



Figure 9-18 Call from Door Station



- On the call from door station interface, press the **Unlock** tab, the building door will open.
- Press the  tab to capture the live view picture when speaking with the door station. And prompts “Captured” will display on the screen.
- Indoor extension can receive the call from the door station and the master station only.

### 7.4.5 Viewing Call Logs

**Steps:**



1. Press the  tab on the touch screen to enter the call log interface.

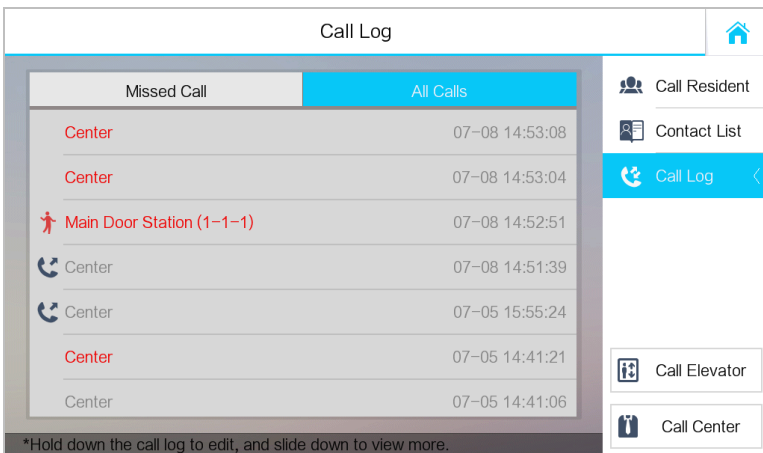
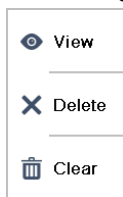

Figure 9-19 Call Logs Interface

2. Press tab **Missed Call** or **All Calls** to view missed call logs or all call logs.



- Indoor extension does not support this function.
- The indoor station saves call logs from door station, outer door station, management center and other indoor stations.
- Hold down a piece of call log to open the call log handling menu.



- Press the **View** tab to enter the live view interface.
- Press the **Delete** tab to delete the piece of call log.
- Press the **Clear** tab to delete all pieces of call logs.
- For the DS-KH6210-L, select a piece of call log and press the **Confirm** key to pop up the captured picture.

## 7.5 Live View



- Make sure the IP camera or door station is well-connected.
- Make sure the indoor extension and the indoor station are well-connected.
- The DS-KH6210-L indoor station does not support the live view of IP camera.

**Purpose:**

On the live view interface, you can monitor the live view of added door station and IP camera.

**Steps:**

1. Press the **Live View** tab on the user interface to enter the live view interface.

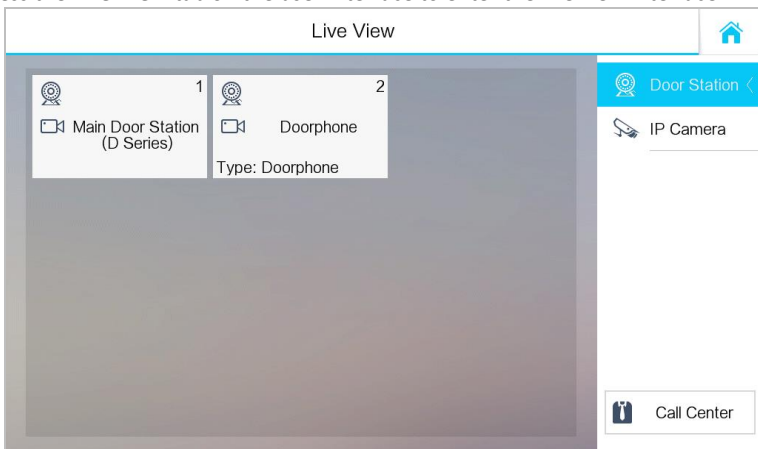

Figure 9-20 Live View Interface

2. Press the **Door Station** tab to enter the live view interface of door station.

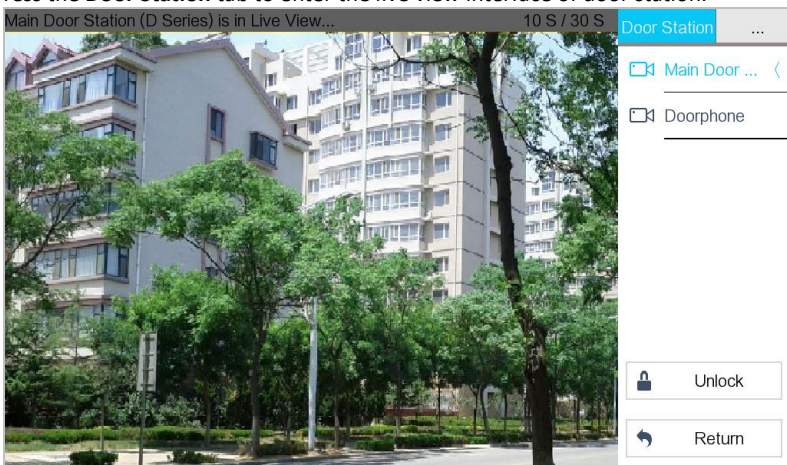

Figure 9-21 Live View of Door Station

3. Press the **IP Camera** tab to enter the live view interface of IP cameras.

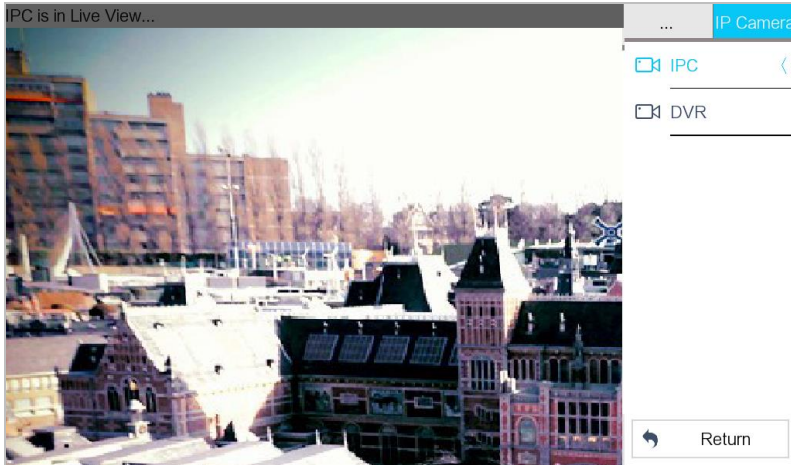

Figure 9-22 Live View of IP Camera



On the door station live view interface, press the **Unlock** tab to open the unit door.

## 7.6 Information Management

You can view public notice, visitor message, alarm log and capture log on information management interface.



Press the **No New Message** tab or the **Information Management** tab to enter the information management interface. (Here take the alarm log interface as example.)

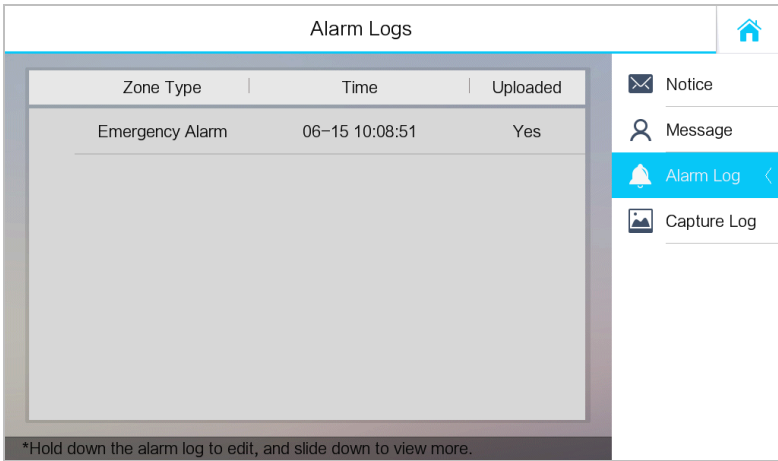



Figure 9-23 Alarm Logs Interface (Indoor Station)



- Indoor extension only supports alarm log and capture log.
- For DS-KH8301-WTS/DS-KH8301-WT/DS-KH8300-T models, it requires TF card for saving the notice, visitor messages and capture logs of the indoor stations, and requires the internal memory of the indoor station to save the alarm log.
- For DS-KH6310/DS-KH6310-W/DS-KH6310-WL/DS-KH6210-L models, it is the internal memory of the indoor station that saves the notice, visitor messages, alarm logs, and capture logs.
- Up to 200 pieces of notice, 200 pieces of visitor messages, 200 pieces of alarm logs, and 200 pieces of capture logs can be saved.
- Hold down the item to delete or clear all items on each interface.
- On the alarm log interface (indoor station), hold down the piece of the alarm log to open the alarm details interface.



| Alarm Details            |  |
|--------------------------|---|
| Event:Active Infrared    |   |
| Alarm Source:Room 1      |   |
| Time:2015-11-23 10:19:44 |   |
| Uploaded:No              |   |
| Zone:Zone 8              |   |

# 8 Remote Operation via Batch Configuration Tool

You can configure and operate the video intercom devices via Batch Configuration Tool. Default parameters of indoor station are as follows:

- Default IP Address: 192.0.0.64.
- Default Port No.: 8000.
- Default User Name: admin.

## 8.1 Activating Device Remotely

### Purpose

You are required to activate the device first by setting a strong password for it before you can use the device.

Activation via Batch Configuration Tool, and Activation via iVMS-4200 are supported. Here take activation via Batch Configuration Tool as example to introduce the device activation. Please refer to the user manual for the activation via iVMS-4200.

### Steps:

1. Run the Batch Configuration Tool.

| Index | Device Type | IP Address  | Port | Software Version    | Serial No.                          | Security Status | Added |
|-------|-------------|-------------|------|---------------------|-------------------------------------|-----------------|-------|
| 1     | XX-XXXX-XX  | 10.16.2.77  | 8000 | Vx.x.x build xxxxxx | XX-XXXXX-XXXXXXXXXXXXXXXXXXXXXXXXXX | Activated       | Yes   |
| 2     | XX-XXXX-XX  | 10.16.2.103 | 8000 | Vx.x.x build xxxxxx | XX-XXXXX-XXXXXXXXXXXXXXXXXXXXXXXXXX | Activated       | No    |
| 3     | XX-XXXX-XX  | 10.16.2.114 | 8000 | Vx.x.x build xxxxxx | XX-XXXXX-XXXXXXXXXXXXXXXXXXXXXXXXXX | Activated       | No    |
| 4     | XX-XXXX-XX  | 10.16.2.222 | 8000 | Vx.x.x build xxxxxx | XX-XXXXX-XXXXXXXXXXXXXXXXXXXXXXXXXX | Activated       | No    |
| 5     | XX-XXXX-XX  | 192.0.0.64  | 8000 | Vx.x.x build xxxxxx | XX-XXXXX-XXXXXXXXXXXXXXXXXXXXXXXXXX | Inactive        | No    |

Figure 8-1 Selecting Inactive Device

2. Select an inactivated device and click the **Activate** button.

**Activate**

Password:

Confirm password:

Valid password range [8-16].  
You can use a combination of numbers, lowercase, uppercase and special character for your password with at least two kinds of them contained.

Figure 8-2 Activation

3. Create a password, and confirm the password.



**STRONG PASSWORD RECOMMENDED**— *We highly recommend you create a strong password of your own choosing (Using a minimum of 8 characters, including at least three of the following categories: upper case letters, lower case letters, numbers, and special characters.) in order to increase the security of your product. And we recommend you reset your password regularly, especially in the high security system, resetting the password monthly or weekly can better protect your product.*

4. Click the **OK** button to activate the device.



- When the device is not activated, the basic operation and remote operation of device cannot be performed.
- You can hold the **Ctrl** or **Shift** key to select multiple devices in the online devices, and click the **Activate** button to activate devices in batch.

## 8.2 Editing Network Parameters

### Purpose:

To operate and configure the device via LAN (Local Area Network), you need connect the device in the same subnet with your PC. You can edit network parameters via batch configuration tool, and iVMS-4200 software. Here take editing network parameters via batch configuration tool as example.

### Steps:

1. Select an online activated device and click the **Edit NET Parameters** button.

| Online Devices: 6  |             |             |      |                     |                                 |                 |       |  |
|--|-------------|-------------|------|---------------------|---------------------------------|-----------------|-------|--|
| <span style="margin-right: 10px;">🔧</span> <span style="margin-right: 10px;">🔗 Edit NET Parameters</span> <span style="margin-right: 10px;">🔄 Reset Password</span> <span>🗨️ Activate</span> |             |             |      |                     |                                 |                 |       |  |
| Index  | Device Type | IP Address  | Port | Software Version    | Serial No.                      | Security Status | Added |  |
| 1  | XX-XXXX-XX  | 192.0.0.64  | 8000 | Vx.x.x build xxxxxx | XX-XXXX-XXXXXXXXXXXXXXXXXXXX... | Activated       | No    |  |
| 2  | XX-XXXX-XX  | 10.16.6.155 | 8000 | Vx.x.x build xxxxxx | XX-XXXX-XXXXXXXXXXXXXXXXXXXX... | Activated       | No    |  |
| 3  | XX-XXXX-XX  | 10.16.6.179 | 8000 | Vx.x.x build xxxxxx | XX-XXXX-XXXXXXXXXXXXXXXXXXXX... | Activated       | No    |  |
| 4  | XX-XXXX-XX  | 10.16.6.126 | 8000 | Vx.x.x build xxxxxx | XX-XXXX-XXXXXXXXXXXXXXXXXXXX... | Activated       | No    |  |
| 5  | XX-XXXX-XX  | 10.16.6.151 | 8000 | Vx.x.x build xxxxxx | XX-XXXX-XXXXXXXXXXXXXXXXXXXX... | Activated       | No    |  |
| 6  | XX-XXXX-XX  | 10.16.6.222 | 8000 | Vx.x.x build xxxxxx | XX-XXXX-XXXXXXXXXXXXXXXXXXXX... | Activated       | No    |  |

Figure 8-3 Clicking Edit NET Parameters Button

2. Change the device IP address and gateway address to the same subnet with your computer.
3. Enter the password and click the **OK** button to activate the network parameters modification.

| Edit NET Parameters   |               |
|---|---------------|
| IP Address:   | 10.16.6.159   |
| Subnet Mask:  | 255.255.255.0 |
| Gateway Address:  | 10.16.6.254   |
| Port No.:   | 8000          |
| Password:   |               |
| <input type="checkbox"/> Enable DHCP                                    |               |
| <input type="button" value="OK"/> <input type="button" value="Cancel"/> |               |

Figure 8-4 Editing Network Parameters



- The default port No. is 8000.
- The default IP address of the indoor station is 192.0.0.64.
- After editing the network parameters of device, you should add the devices to the device list again.
- Enable DHCP, and the software can obtain network parameters for the device automatically.

## 8.3 Adding Device

### ***Before you start:***

Make sure the device to be added has been activated.

### ***Purpose:***

For batch configuration tool software, you should add device to the software so as to configure the device remotely.

The software provides 3 ways for adding the devices. You can add the active online devices within your subnet, add devices by IP address, and add devices by IP segment.

### 8.3.1 Adding Online Device

#### ***Before you start:***

Make sure the device to be added is in the same subnet with your computer. Otherwise, please edit network parameters first.

#### ***Steps:***

1. Select an active online device or hold the **Ctrl** or **Shift** key to select multiple devices in the online devices list.

| Index | Device Type | IP Address  | Port | Software Version     | Serial No.                     | Security Status | Added |
|-------|-------------|-------------|------|----------------------|--------------------------------|-----------------|-------|
| 1     | XX-XXXX-XX  | 10.16.2.77  | 8000 | Vx.x.x build xxxxxxx | XX-XXXX-XXXXXXXXXXXXXXXXXXXXXX | Activated       | Yes   |
| 2     | XX-XXXX-XX  | 10.16.2.114 | 8000 | Vx.x.x build xxxxxxx | XX-XXXX-XXXXXXXXXXXXXXXXXXXXXX | Activated       | No    |
| 3     | XX-XXXX-XX  | 10.16.2.103 | 8000 | Vx.x.x build xxxxxxx | XX-XXXX-XXXXXXXXXXXXXXXXXXXXXX | Activated       | No    |
| 4     | XX-XXXX-XX  | 10.16.2.88  | 8000 | Vx.x.x build xxxxxxx | XX-XXXX-XXXXXXXXXXXXXXXXXXXXXX | Activated       | No    |
| 5     | XX-XXXX-XX  | 10.16.2.222 | 8000 | Vx.x.x build xxxxxxx | XX-XXXX-XXXXXXXXXXXXXXXXXXXXXX | Activated       | No    |

Figure 8-5 Online Devices Interface

2. Click the  button to pop up the login dialog box.

Login

**Log into the selected device(s):**

User Name:

Password:

OK
Cancel

Figure 8-6 Login Dialog Box

3. Enter the user name and password.
4. Click the **OK** button to save the settings.



- Only devices successfully logged in will be added to the device list for configuration.
- If you add devices in batch, please make sure selected devices have the same user name and password.

### 8.3.2 Adding by IP Address

**Purpose:**

You can add the device by entering IP address.

**Steps:**

1. Click the  button to pop up the adding devices dialog box.

Device(s) in the list will be configured.

Device List 1
Remote Configurator
Flash rom
Batch Update
Linked Network Batch Configuration
Filter: Device List

| Index                    | Device Type | IP Address | Port      | Software Version | Serial No.            | Security Status              | Configuration Status | Configuration |
|--------------------------|-------------|------------|-----------|------------------|-----------------------|------------------------------|----------------------|---------------|
| <input type="checkbox"/> | 1           | XX-XXXX-XX | 10.16.2.8 | 8000             | V x.x.x build xxxxxxx | XX-XXXX-XXXXXXXXXXXXXXXXXXXX | Strong password      |               |

Figure 8-7 Adding Button

2. Select IP Address in the adding mode drop-down list.
3. Enter the IP address, and set the port No., user name and password of the device.

Figure 8-8 Adding by IP Address

4. Click the **OK** button to add the device to the device list.



- You cannot add the device(s) to the device list if the user name and password are not identical.
- When you add devices by IP Address, IP Segment or Port No., the devices should be online devices.

### 8.3.3 Adding by IP Segment

**Purpose:**

You can add many devices at once whose IP addresses are among the IP segment.

**Steps:**

1. Click the button to pop up the adding devices dialog box.

| Index | Device Type | IP Address | Port | Software Version     | Serial No.                | Security Status | Configuration Status | Configuration |
|-------|-------------|------------|------|----------------------|---------------------------|-----------------|----------------------|---------------|
| 1     | XX-XXXX-XX  | 10.16.2.8  | 8000 | V x.x.x build xxxxxx | XX-XXXXXXXXXXXXXXXXXXXXXX | Strong password |                      |               |

Figure 8-9 Adding Button

2. Select IP Segment in the adding mode drop-down list.
3. Set the Start IP Address and End IP Address.
4. Enter port No., user name, and password.

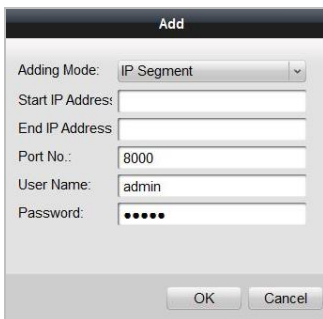

Figure 8-10 Adding by IP Segment

5. Click the **OK** button to search and add the devices whose IP addresses are within the range of the defined IP segment to the device list.

## 8.4 Configuring Devices Remotely

In the device list area, select a device and click **Remote Configuration** or to enter the remote configuration interface.

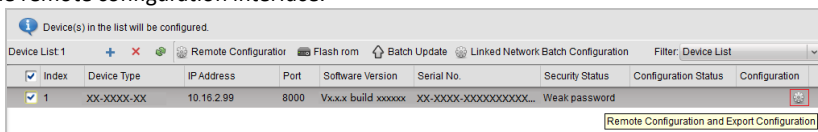

Figure 8-11 Remote Configuration



Here we take the indoor station as an example, and the remote configuration of other devices can be referred.

### 8.4.1 System

Click the **System** button on the remote configuration interface to display the device information: Device Information, General, Time, System Maintenance, User, and RS485.

#### Device Information

Click the **Device Information** button to enter device basic information interface. You can view basic information (the device type, and serial No.), and version information of the device.

**Basic Information**

Device Type: XX-XXXX-XX

Device Serial No.: XX-XXXX-XXXXXXXXXXXXXXXXXXXX

**Version Information**

Version: Vx.x.x build xxxxxx

Hardware Version: xxxxxx

Figure 8-12 Device Information

## General

Click the **General** button to enter device general parameters settings interface. You can view and edit the device name and device ID.

**Device Information**

Device Name: Room 1

Device No.: 255

Save

Figure 8-13 General

## Time

### Steps:

1. Click the **Time** button to enter the device time settings interface.

**Time Zone**

Select Time Zone: (GMT+08:00) Beijing, Hong Kong, Perth, Singap... ▾

Enable NTP

Server Address: 0.0.0.0

NTP Port: 123

Sync Interval: 60 Minute(s)

Enable DST

Start Time: April ▾ First Week ▾ Sun ▾ 2 : 00

End Time: October ▾ Last Week ▾ Sun ▾ 2 : 00

DST Bias: 60 min ▾

Synchronization Save

Figure 8-14 Time Settings

2. Select Time Zone or Enable NTP.

- **Time Zone**

- 1) Select a time zone from the drop-down list menu.



- 2) Click the **Synchronization** button.
  - **NTP**
    - 1) Check the checkbox of Enable NTP to enable NTP.
    - 2) Enter the server address, NTP port, and synchronization interval.
  - **DST**
    - 1) Check the checkbox of Enable DST to enable DST.
    - 2) Enter the start time and end time of DST, and set the DST bias.
3. Click the **Save** button to save and realize the time settings.



The default port No. is 123.

## System Maintenance

### **Purpose:**

You can operate the system management and remote upgrading on the system maintenance interface.

### **Steps:**

1. Click the **System Maintenance** button to enter the system maintenance interface.

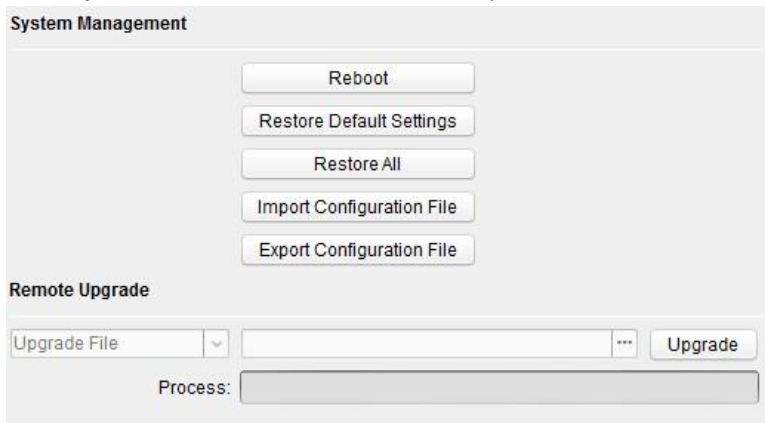

Figure 8-15 System Maintenance

2. Click **Reboot** and the system reboot dialog box pops up. Click **Yes** to reboot the system.
3. Click **Restore Default Settings** to restore the default parameters.
4. Click **Restore All** to restore all parameters of device and reset the device to inactive status.
5. Click **Import Configuration File** and the import file window pops up. Select the path of remote configuration files. Click **Open** to import the remote configuration file. The configuration file is imported and the device will reboot automatically.

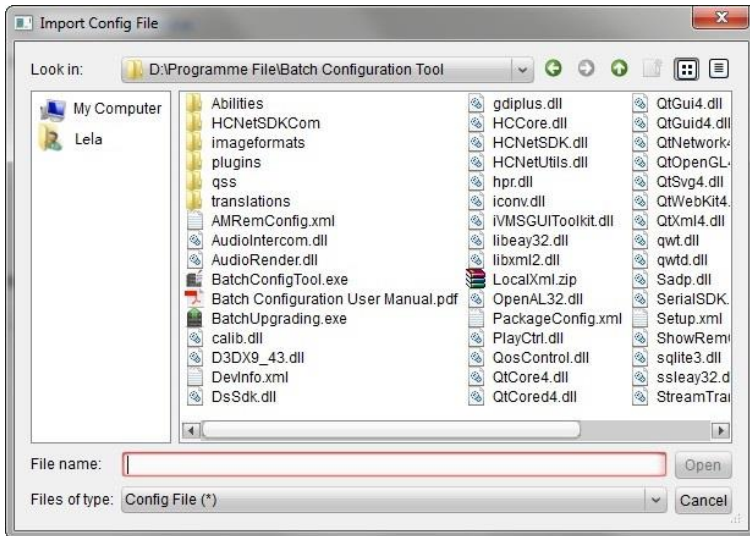

Figure 8-16 Import File

- Click **Export Configuration File** and the export file window pops up. Select the saving path of remote configuration files and click **Save** to export the configuration file.

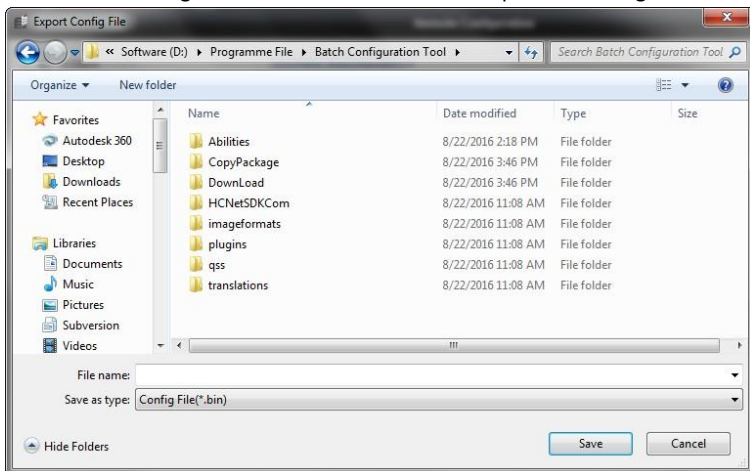



Figure 8-17 Export File

- Click  to select the upgrade file and click **Upgrade** to remote upgrade the device. The process of remote upgrade will be displayed in the process bar.

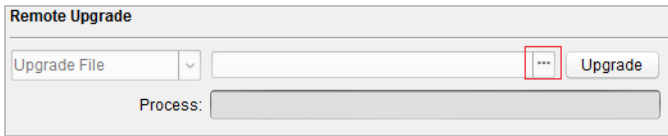

Figure 8-18 Remote Upgrade



- Click **Restore Default Settings** button, all default settings, excluding network parameters, will be restored.
- Click **Restore All** button, all default settings, including network parameters, will be restored. The device will be reset to inactivated status.

## User

### Purpose:

You can edit the password for logging in the device.

### Steps:

1. Click the **User** button to enter the user information editing interface.



Figure 8-19 Select User Name

2. Select the user to edit and click the **Modify** button to enter the user parameter interface.

Figure 8-20 Modify User Information

3. Enter the new password, and confirm it.
4. Click the **Save** button to realize the editing of password.



- The new password and confirm password should be identical.
- After editing the password of device, click  button from the device list, the added device will not be there. You should add the device again with new password to operate the remote configuration.

## RS485

Click the **RS485** button to enter the RS485 setting interface. You can view and edit the RS485 parameters of the device.

Figure 8-21 RS-485



For indoor station and master station, there are 3 choices for the working mode: transparent channel, disable, and custom.

## 8.4.2 Video Intercom

Click the **Video Intercom** button on the remote configuration interface to enter the video intercom parameters settings: Device Number Configuration, Time Parameters, Password, Zone Configuration, IP Camera Information, and Volume Input and Output Configuration, and so on.

### Device ID Configuration

#### Steps:

1. Click the **ID Configuration** button to enter device ID configuration interface.

Figure 8-22 Indoor Station

Figure 8-23 Indoor Extension

2. Select the device type from the drop-down list, and set the corresponding information.
3. Click the **Save** button to enable the device number configuration.

### Time Parameters

1. Click the **Time Parameters** button to enter time parameters settings interface.
2. Configure the maximum ring duration, maximum live view time, and call forwarding time.
3. Click the **Save** button.

Figure 8-24 Time Parameters



- Maximum ring duration is the maximum duration of indoor station when it is called without being received. The range of maximum ring duration varies from 30s to 60s.

- Maximum live view time is the maximum time of playing live view of the indoor station. The range of maximum live view time varies from 10s to 60s.
- Call forwarding time refers to the ring duration limit beyond which the call is automatically forwarded to the mobile phone designated by the resident. The range of call forwarding time varies from 0s to 20s.
- For indoor extension, it only requires setting the maximum live view time.

## Password

Click the **Password** button to enter password changing interface.

For indoor station, you can change the admin password, arm/disarm password, unlock password and duress code.

Figure 8-25 Password Configuration



For indoor extension, only admin password and arm/disarm password need to be configured.

## Volume Input and Output

### Step:

1. Click **Volume Input/Output** button to enter the volume input and output interface.

Figure 8-26 Volume Configuration



2. Slide the slider to adjust the volume input and volume output.
3. Click the **Save** button to enable the settings.

## Ring Import

Click the **Ring Import** button to enter the ring configuration interface.

| Configure Ring parameters |        |        |      |     |        |
|---------------------------|--------|--------|------|-----|--------|
| No.                       | Name   | Size   | Type | Add | Remove |
| 1                         | Ring 1 | 123098 | wav  | +   | ×      |
| 2                         | Ring 2 | 124324 | wav  | +   | ×      |
| 3                         | Ring 3 | 123098 | wav  | +   | ×      |
| 4                         | Ring 4 | 124324 | wav  | +   | ×      |

Figure 8-27 Ringtone Configuration

Click  to add the ring, and click  to delete the imported ring.



- The ring to be imported should be in the wav format, and the size of the ring cannot be larger than 300k.
- Up to 4 rings can be added.

## Zone

1. Click the **Zone Alarm** button to enter zone settings interface.

**Zone Alarm**

Zone No.:  ▾

Zone Type:  ▾

Alarm Type:  ▾

NO/NC:  ▾

Entering Delay:  s

Exiting Delay:  s

Figure 8-28 Zone Alarm

2. Select a zone type from the drop-down list menu.
3. Select an alarm mode from the drop-down list menu.
4. Set the zone status: NO or NC.
5. Set the entering delay, and exiting delay.
6. Click the **Save** button to enable zone settings.



- Six zone types are supported: Emergency Switch, Door Magnetic Switch, Smoke Detector, Active IR Detector, Passive IR Detector, and Combustible Gas Detector.
- Three types of alarm mode are supported: Instant Alarm, 24H Alarm, and Delay Alarm.

- When the zone type is set to be Instant Alarm, only under arming mode, the indoor station will receive alarm message when the detector is triggered. Under disarming mode, it will not receive alarm message when the detector is triggered.
- When the zone type is set to be 24H Alarm, the indoor station will receive alarm message when the detector is triggered no matter it is under arming mode or disarming mode.
- When the zone type is set to be Delay Alarm, only under arming mode, the indoor station will receive alarm message when the detector is triggered. Under disarming mode, it will not receive alarm message when the detector is triggered.
- After setting enter delay time, if the OK button is pressed within the enter delay time after the alarm, the alarm event will not be uploaded to the management center; if the OK button is not pressed within the enter delay time after the alarm, the alarm event will be uploaded to the management center.
- The exit delay is the time between you enable the arming mode and the arming takes effect.

## IP Camera Information

### Purpose:

You can add, delete and modify devices that can be added to the video intercom products, such as network IP cameras, door stations, doorphones, outer door stations, DVR/NVR/DVS, with two ways of getting stream: direct or URL. By exporting and importing the added device information, you can edit added devices parameters in batch.

### Adding IP Camera, DVR/NVR/DVS, and Doorphone

#### Steps:

1. Click the **IP Camera Information** button to enter IP camera information interface.

The screenshot shows the 'IP Camera Information' interface. At the top, there are five buttons: 'Add', 'Modify', 'Delete', 'Export', and 'Import'. Below the buttons is a table with the following data:

| Index | Device Name | Getting Stream...   URL | Manufacturer Protocol | User  | Password | IP Address | Port |
|-------|-------------|-------------------------|-----------------------|-------|----------|------------|------|
| 1     | IPC         | Direct                  | XXXProtocol           | admin | *****    | 10.16.2.1  | 8000 |
| 2     | DVR         | Direct                  | XXXProtocol           | admin | *****    | 10.16.2.5  | 8000 |
| 3     | Doorphone   | Direct                  | XXXProtocol           | admin | *****    | 10.16.2.56 | 8000 |

Figure 8-29 IP Camera Information

2. Click the **Add** button to pop up the device adding dialogue box.
3. Select the device type from the drop-down list menu: IP Camera, DVR/NVR/DVS, and doorphone.
4. Enter corresponding information (device name, IP address, port No., user name, password, etc.), and click the **OK** button.



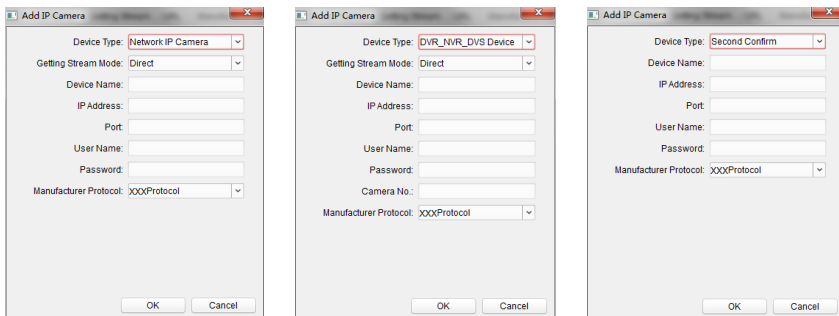

Figure 8-30 Adding Devices



Indoor extension does not support this function.

### Exporting and Importing Added Device Information

#### Steps:

1. Click the **Export** button to export the added device information file.

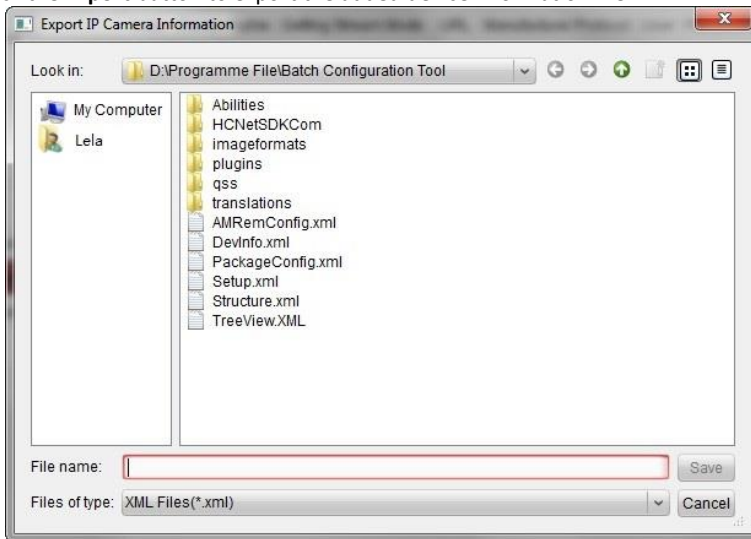

Figure 8-31 Export Information

2. Edit parameters of added devices in batch in the exported file.
3. Click the **Import** button to pop up importing box, and open the edited added device information file.

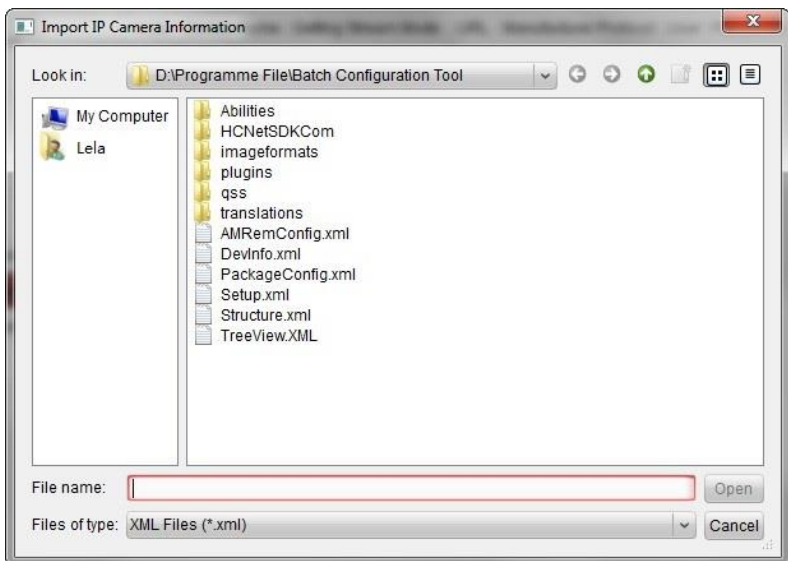

Figure 8-32 Import Information

## 8.4.3 Network

### Local Network Configuration

#### Steps:

1. Click the **Local Network Configuration** button to enter local network configuration interface.

| Local Network Configuration         |  |
|-------------------------------------|--|
| Local IP Address:                   | <input type="text" value="10.16.6.145"/>   |
| IP Address Subnet Mask:             | <input type="text" value="255.255.255.0"/> |
| Default Gateway:                    | <input type="text" value="10.16.6.254"/>   |
| Port:                               | <input type="text" value="8000"/>          |
| HTTP Port:                          | <input type="text" value="80"/>            |
| <input type="button" value="Save"/> |  |

Figure 8-33 Local Network Parameters

2. Enter the local IP address, subnet mask, gateway address, and port No..
3. Click the **Save** button to enable the settings.



- The default port No. is 8000.
- After editing the local network parameters of device, you should add the devices to the device list again.

## Linked Devices Network Configuration

### Purpose:

In the linked devices network configuration interface, you can configure the network parameters of master stations, SIP servers and management centers of the same LAN. The devices can be linked to the door station and realize the linkage between these devices.

### Steps:

1. Click the **Linked Network Configuration** button to enter linked network configuration interface.

The screenshot shows a web-based configuration interface titled "Linked Network Configuration". It features several input fields and dropdown menus. The "Device Type" dropdown is set to "Indoor Station". The "Master Station IP Address" field contains "0.0.0.0". The "(Main) Door Station IP Address" field contains "10.16.6.124". The "SIP Server IP Address" field contains "10.16.6.37". The "Security Control Panel IP Address" field contains "10.16.2.17". The "Security Control Panel Port No." field contains "8000". The "Main Door Station Type" dropdown is set to "Main Door Station (D S...". The "Network Connection Mode" dropdown is set to "Same LAN". A "Save" button is positioned at the bottom right of the form.

Figure 8-34 Linked Network Configuration

2. Enter the master station IP address, (main) door station IP address, SIP server IP address, management center IP address, and doorphone IP address.
3. Select the main door station type from the drop-down list.
4. Click the **Save** button to enable the settings.



- After adding master station IP Address, the linkage between indoor station and master station can be realized.
- After adding the door station IP Address, the video intercom between indoor stations of same building can be realized.
- After adding SIP Server Address IP, the video intercom of same community: video intercom between indoor stations of different building, calling indoor station from outer door station and video intercom between management center and indoors.
- After adding management center IP Address, the events can be uploaded to the management center.

- For indoor extension, only parameter about the main indoor station should be configured.

## 8.5 Video Intercom Device Set-up Tool

### Purpose:

You can assign the device to the community, activate and set the device, and configure the network parameters and linked network parameters for the device by using the video intercom device set-up tool.

In the device list area, click **Flash rom** to enter the video intercom device set-up tool.

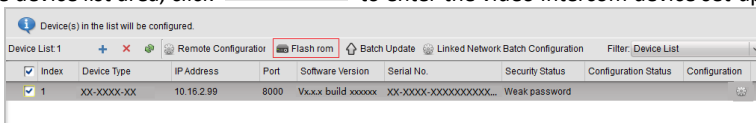

Figure 8-35 Video Device Set-up Tool

### 8.5.1 Setting a Community Structure

Set a community structure in the video intercom device set-up tool first, based on the real community situation, and then assign devices to the community accordingly.

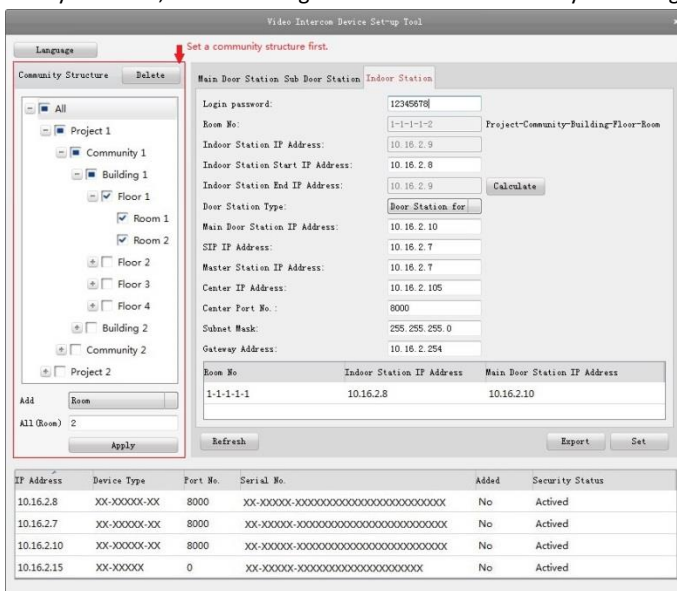

Figure 8-36 Setting a Community Structure

## 8.5.2 Setting Indoor Station

### Purpose:

You can activate the online indoor station, and configure the room No. for the online indoor station.

### Steps:

1. Press the **Indoor Station** tab to switch to the indoor station configuration interface.

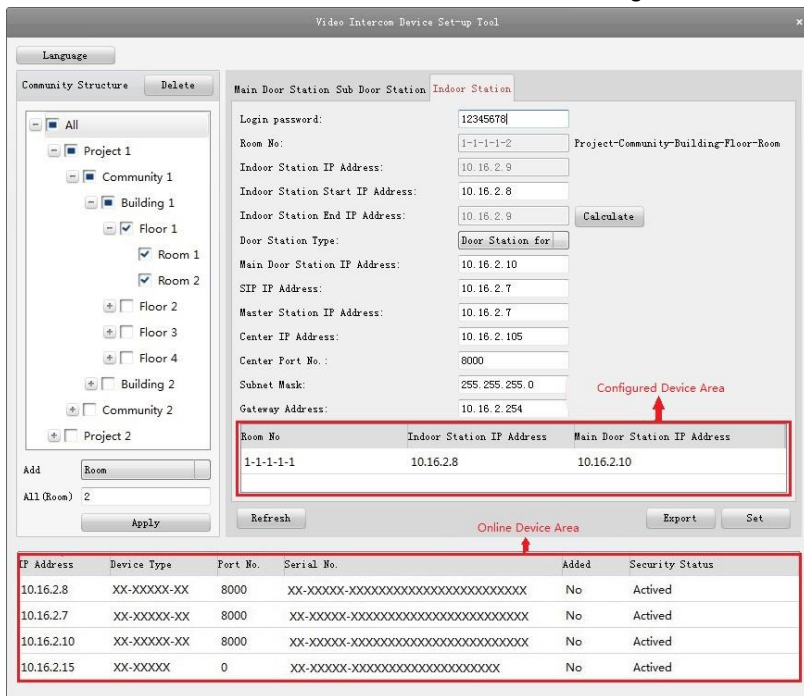

Figure 8-37 Setting Indoor Station

2. Select a community, and enter the indoor station start IP address, and then click the **Calculate** button to generate the indoor station end IP address and indoor station room No. (like 1-1-1-2) automatically.
3. Set the main door station parameters: door station type (door station for unit, or door station for villa), main door station IP address.
4. Set the linked network parameters for the indoor station: SIP IP address, master station IP address, center IP address, center port No., subnet mask, and gateway address.
5. Select an online door station, enter the login password, and click the **Set** button.



- The indoor station configured successfully will be listed in the configured device area. At the same time, the next indoor station can be easily configured by selecting another indoor station in the online device area and clicking the **Set** button.
- For the login password, if the indoor station has been activated, enter the activation password here. If the indoor station is not activated, create a login password here, and the indoor station will be activated simultaneously.
- When the device is successfully configured, it prompts the note: Configuring main door station parameters succeeded.

## 8.6 Batch Upgrading

In the device list area, click  **Batch Update** to enter the batch upgrading interface.

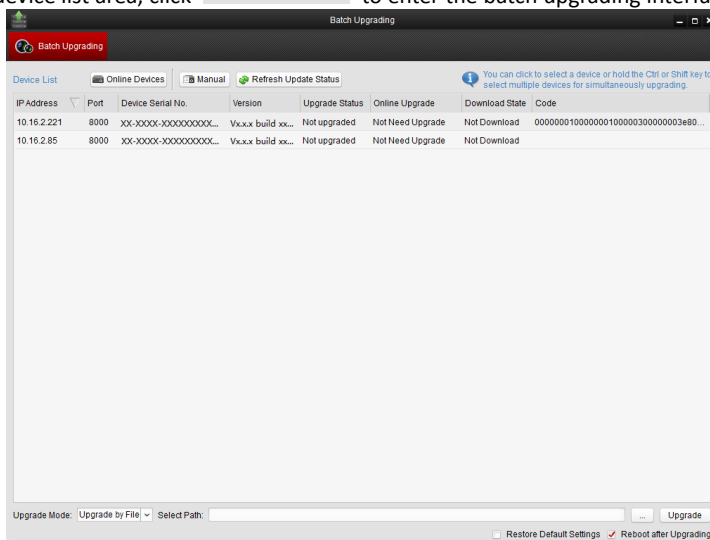

Figure 8-38 Batch Upgrading

### 8.6.1 Adding Devices for Upgrading

You should add the device to the batch upgrading tool first before upgrading the device. There are 2 ways to add the device: adding online device, and adding by IP address/IP segment.

#### Adding Online Device

**Steps:**

1. In the batch upgrading interface, click the **Online Devices** to open the online device window.

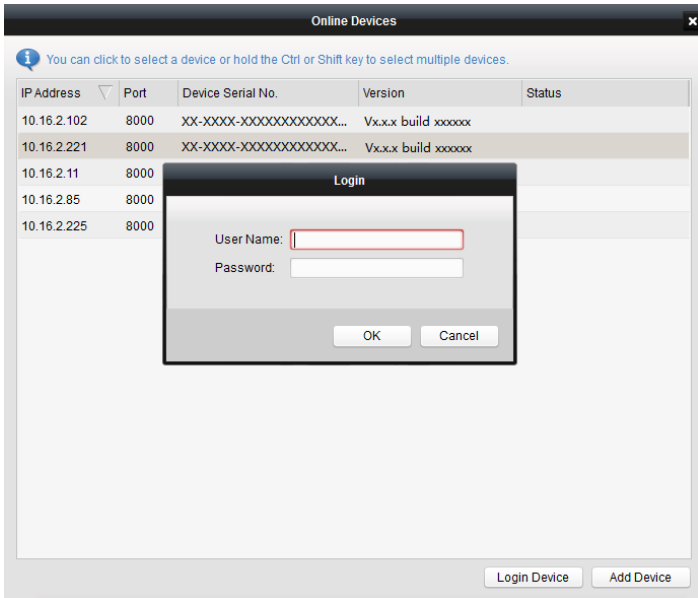

Figure 8-39 Login

2. Select a device, enter the user name and password, and click the **Login Device** button.
3. Click the **Add Device** button, and the device is added to the batch upgrading tool.

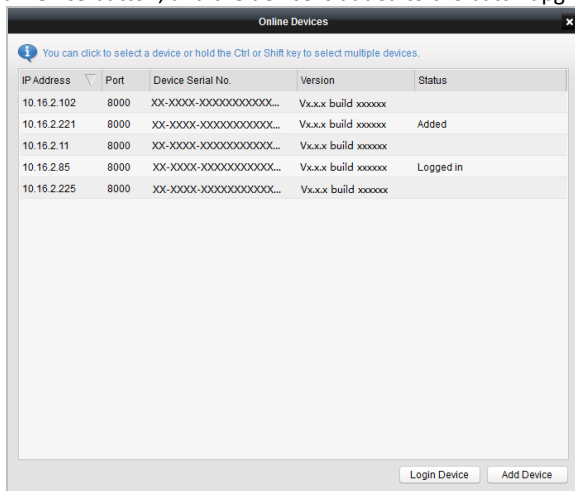

Figure 8-40 Online Devices

## Adding by IP Address/IP Segment

### Steps:

1. Click the **Manual** button to open the device adding window.
2. Enter the corresponding information (IP address, user name, password, start IP address, end IP address).
3. Click the **Add** button.

The screenshot shows a 'Search' dialog box with two sections: 'By IP' and 'By IP Segmen'. The 'By IP' section has fields for 'IP Address', 'Port' (set to 8000), 'User Name', and 'Password', with an 'Add>>' button. The 'By IP Segmen' section has fields for 'Start IP', 'End IP', 'Port' (set to 8000), 'User Name', and 'Password', with an 'Add>>' button. A 'Cancel' button is at the bottom right.

Figure 8-41 Adding by IP Address/IP Segment

## 8.6.2 Upgrading Devices

There are 2 upgrading modes available: upgrading by file, and online upgrading.

### Upgrading by File

Upgrading by File: You upgrade the device or devices via the local upgrade files.

### Steps:

1. Select a device or multiple devices, and select "Upgrade by File" as the upgrading mode.
2. Click  to pop up the window for opening the upgrading file.



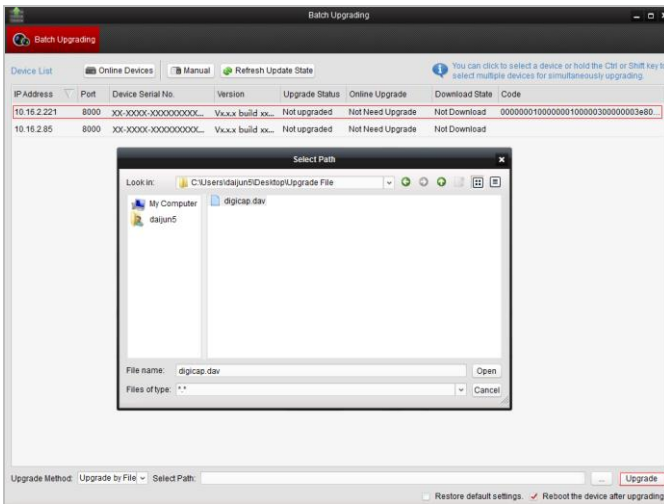

Figure 8-42 Upgrade by File

3. Open the upgrading file, and click the **Upgrade** button.

### Online Upgrading

Online Upgrading: The batch upgrading tool will search the latest upgrading file for the device automatically. You upgrade the device or devices via the local upgrading files.

**Steps:**

1. Select a device or multiple devices, and select “Online Upgrade” as the upgrading mode.
2. Click the **Download** button. Click the **Upgrade** button after the online upgrading file has been wholly downloaded.

## 9 Remote Operation via iVMS-4200

The Video Intercom module provides remote control and configuration on video intercom products via the iVMS-4200 client software.

Before remote configure and control the video intercom, you are required to add the device to the software first. Refer to *9.2 Device Management*.

For remote configuration of video intercom device via the iVMS-4200 client software, refer to *9.3 Configuring Devices Remotely via iVMS-4200*.

For the picture storage on storage server, refer to *9.4 Picture Storage*.

For remote control of video intercom devices, please refer to *9.5 Video Intercom Configuration*.

### 9.1 System Configuration

#### **Purpose:**



You can configure the video intercom parameters accordingly.

#### **Steps:**

1. Open the System Configuration page.

Path: **Control Panel -> Maintenance and Management -> System Configuration -> Video Intercom.**

2. Click the **Video Intercom** tab to enter the Video Intercom Settings interface.
3. Input the required information.

**Ringtone:** Click the icon  and select the audio file from the local path for the ringtone of indoor station. Optionally, you can click the icon  for a testing of the audio file.

**Max. Ring Duration:** Input the maximum duration of the ringtone, ranging from 15 seconds to 60 seconds.

**Max. Speaking Duration with Indoor Station:** Input the maximum duration of speaking with the indoor station, ranging from 120 seconds to 600 seconds.

**Max. Speaking Duration with Door Station:** Input the maximum duration of speaking with the door station, ranging from 90 seconds to 120 seconds.

**Card Reader Type:** Select the card reader to issue cards.

4. Click **Save** to save the settings.

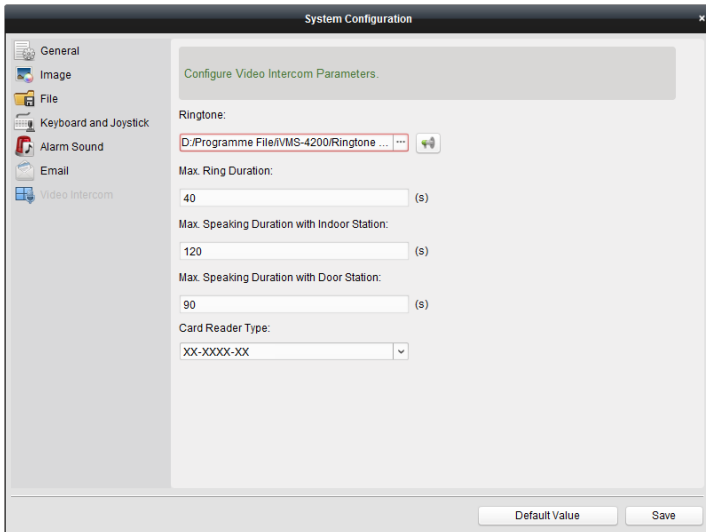

Figure 9-1 System Configuration Interface

## 9.2 Device Management

### **Purpose:**

Device management includes device activation, adding device, editing device, and deleting device, and so on.

After running the iVMS-4200, video intercom devices should be added to the client software for remote configuration and management.

### 9.2.1 Adding Video Intercom Devices



- You can add at most 512 indoor stations and master stations in total to the iVMS-4200, and add at most 16 door stations to the iVMS-4200.
- For video intercom devices, you are required to create the password to activate them before they can be added to the software and work properly. For device activation via creating password, please refer *User Manual of iVMS-4200 (Video Intercom) V2.4.2* in the disk for detail steps.
- You can add online video intercom devices, and add them manually. Here take adding online video intercom devices as example. For adding video intercom devices manually, please refer *User Manual of iVMS-4200 (Video Intercom) V2.4.2* in the disk for detail steps.

### **Steps:**



1. Click the  icon on the control panel, or click **Tools->Device Management** to open the Device Management page.
2. Click the **Server** tab.

**To add indoor station or master station:**

- 1) Click **Add New Device Type** to enter add new device type interface.  
Select **Indoor Station/Master Station** and click **OK**.

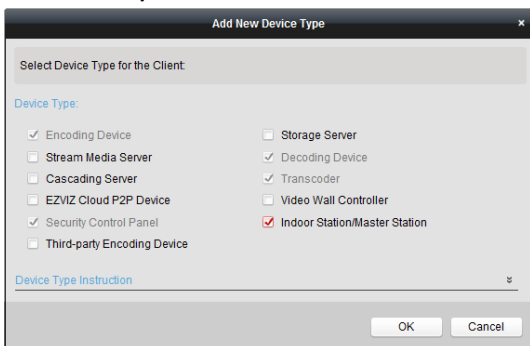

Figure 9-2 Adding New Device Type

- 2) In the Server tab, Video Intercom Device will display, select **Video Intercom Device** and add indoor station and master station.

**To add door station:**

In the Server tab, select **Encoding Device/Outdoor Device** and add door station.

3. The active online devices in the same local subnet with the client software will be displayed on the **Online Device** area. You can click the **Refresh Every 60s** button to refresh the information of the online devices.

| IP          | Device Type | Firmware Version    | Security | Server Port | Start Time          | Added |
|-------------|-------------|---------------------|----------|-------------|---------------------|-------|
| 10.16.2.11  | XX-XXXX-XX  | Vx.x.x build xxxxxx | Active   | 8000        | 2016-07-05 09:21:55 | No    |
| 10.16.2.85  | XX-XXXX-XX  | Vx.x.x build xxxxxx | Active   | 8000        | 2019-01-21 21:43:24 | Yes   |
| 10.16.2.102 | XX-XXXX-XX  | Vx.x.x build xxxxxx | Active   | 8000        | 2016-07-05 09:33:52 | No    |

Figure 9-3 Online Device



To add online devices to the software, you are required to change the device IP address to the same subnet with your computer first.

4. Select the devices to be added from the list.
5. Click **Add to Client** to open the device adding dialog box.
6. Input the required information.
  - Nickname:** Edit a name for the device as you want.
  - Address:** Input the device's IP address. The IP address of the device is obtained automatically in this adding mode.
  - Port:** Input the device port No.. The default value is 8000.
  - User Name:** Input the device user name. By default, the user name is admin.
  - Password:** Input the device password. By default, the password is **12345**.
7. Optionally, you can check the checkbox **Export to Group** to create a group by the device name. All the channels of the device will be imported to the corresponding group by default.



iVMS-4200 also provides a method to add the offline devices. Check the checkbox **Add Offline Device**, input the required information and the device channel number and alarm input number, and then click **Add**. When the offline device comes online, the software will connect it automatically.

8. Click **Add** to add the device.

Figure 9-4 Adding Device by IP/Domain



### Add Multiple Online Devices

If you want to add multiple online devices to the client software, click and hold Ctrl key to select multiple devices, and click **Add to Client** to open the device adding dialog box. In the pop-up message box, enter the user name and password for the devices to be added.

### Add All the Online Devices

If you want to add all the online devices to the client software, click Add All and click **OK** in the pop-up message box. Then enter the user name and password for the devices to be added.

## 9.2.2 Modifying Network Information

Select the device from the online list, click **Modify Netinfo**, and then you can modify the network information of the selected device.

Figure 9-5 Modifying Network Parameter



You should enter the admin password of the device in the **Password** field of the pop-up window to modify the parameters.

### 9.2.3 Resetting Password

According to the different video intercom devices, the software provides two different methods for restoring the default password or resetting the password.

Select the device from the online device list, click **Reset Password**.

#### Option 1:

If the window with import file button, key importing mode drop-down list, password and confirm password field pops up, follow the steps below to reset the password:



This option is available to door stations.

Figure 9-6 Resetting Password (Option 1)

1. Click **Export** to save the device file on your computer.
2. Send the file to our technical engineers.
3. Our technical engineer will send you a file to you. After receiving a file from the technical engineer, select **Import File** from Key Importing Mode drop-down list and click to import the file.
4. Input new password in text fields of **Password** and **Confirm Password**.
5. Click **OK** to reset the password.

**STRONG PASSWORD RECOMMENDED**– *We highly recommend you create a strong password of your own choosing (Using a minimum of 8 characters, including at least three of the following categories: upper case letters, lower case letters, numbers, and special characters.) in order to increase the security of your product. And we recommend you reset your password regularly, especially in the high security system, resetting the password monthly or weekly can better protect your product.*



**Option 2:**

If the window with import file and export file buttons, password and confirm password field pops up, follow the steps below to reset the password:

**Note:** This option is available to indoor stations and master stations.

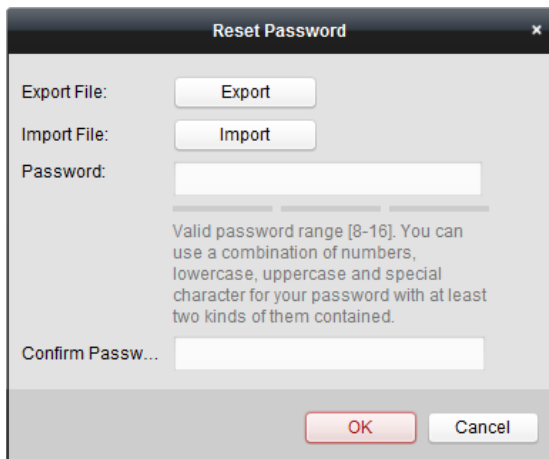

Figure 9-7 Resetting Password (Option 2)

1. Click **Export** to save the device file on your computer.
2. Send the file to our technical engineers.
3. Click **Import** and select the file received from the technical engineer.
4. Input new password in text fields of **Password** and **Confirm Password**.
5. Click **OK** to reset the password.

**STRONG PASSWORD RECOMMENDED**— *We highly recommend you create a strong password of your own choosing (Using a minimum of 8 characters, including at least three of the following categories: upper case letters, lower case letters, numbers, and special characters.) in order to increase the security of your product. And we recommend you reset your password regularly, especially in the high security system, resetting the password monthly or weekly can better protect your product.*



## 9.3 Configuring Devices Remotely via iVMS-4200

Configuring devices remotely via iVMS-4200 is the same with that via Batch Configuration Tool, please refer 8.4 *Configuring Devices Remotely* for detail steps.



## 9.4 Picture Storage

When the video intercom device is under armed status, it will capture the picture automatically after unlocking the door. The captured picture can be uploaded and stored in the storage server.

When starting the live view of door station via iVMS-4200, you can capture the live view picture. The captured picture can be uploaded and stored in the storage server.



- This function is only available to door stations.
- You are required to add storage server to the iVMS-4200, and format the HDDs first before uploading and storing captured pictures.

### 9.4.1 Adding Storage Server

#### **Before you start:**

The storage server application software needs to be installed and it is packed in the iVMS-4200 software package. When installing the iVMS-4200, check the checkbox of **Storage Server** to enable the installation of storage server.

1. Click the icon  on the desktop to run the storage server.
2. Open the Device Management page and click the **Server** tab.
3. Click **Add New Device Type**, select **Storage Server** and click **OK**.

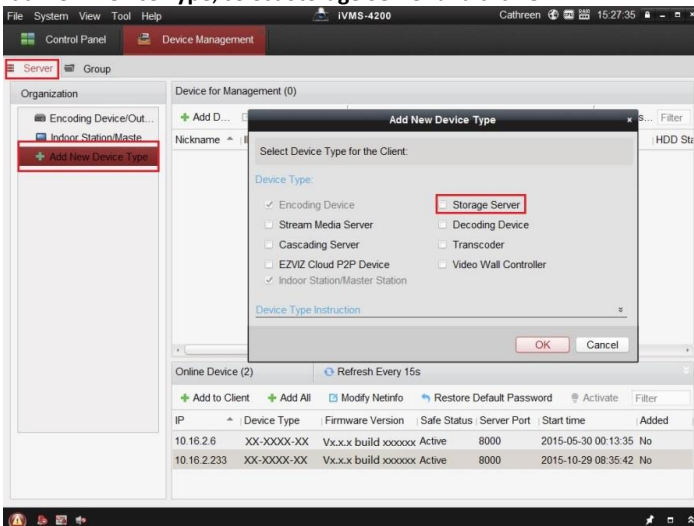

Figure 9-8 Adding Storage Server Type

- Click **Storage Server** on the list to enter the Storage Server Adding interface.



For adding the storage server, please refer to 9.2.1 *Adding Video Intercom Devices*, or *User Manual of iVMS-4200 (Video Intercom) V2.4.2* in the disk.

## 9.4.2 Formatting the HDDs

The HDDs of the storage server need to be formatted for the captured picture storage.

### Steps:

- Select the added storage server from the list and click **Remote Config**.
- Click **Storage->General** to enter the HDD Formatting interface.
- Select the HDD from the list and click **Format**. You can check the formatting process from the process bar and the status of the formatted HDD changes from *Unformatted* to *Normal Status*.

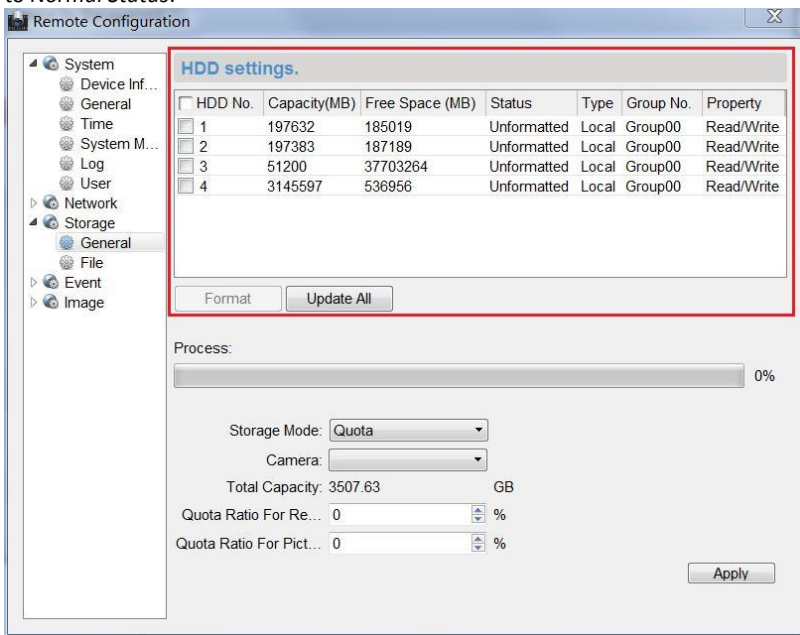

Figure 9-9 Formatting HDDs



Formatting the HDDs is to pre-allocate the disk space for storage and the original data of the formatted HDDs will be deleted.

### 9.4.3 Configuring Storage Server Picture Storage

#### **Before you start:**

The storage server needs to be added to the client software and the HDDs need to be formatted for the captured pictures storage.

#### **Steps:**

1. Open the Record Schedule page.
2. Select the camera from the Camera Group list.
3. Select the storage server from the **Storage Server** drop-down list.



You can click **Storage Server Management** to add, edit or delete the storage server.

4. Check the checkbox of **Picture Storage** to store the alarm pictures of the camera when event occurs.

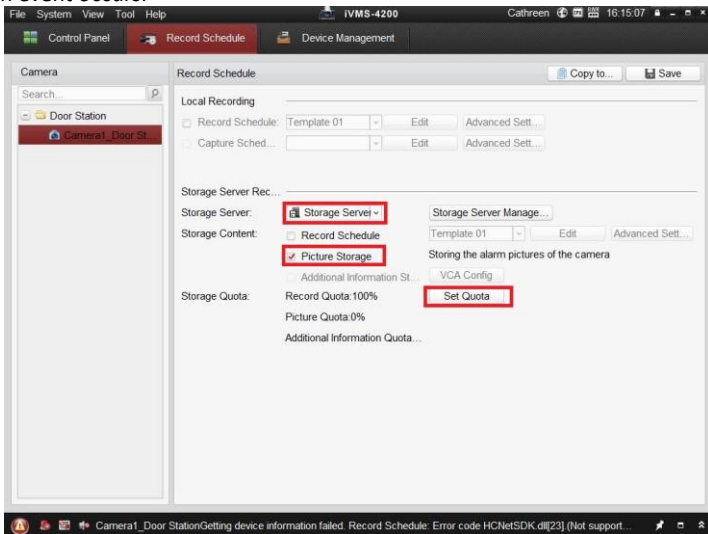

Figure 9-10 Setting Storage Server

5. Click **Set Quota** to enter the HDD management interface of the storage server. You can set the corresponding quota ratio for captured picture information.

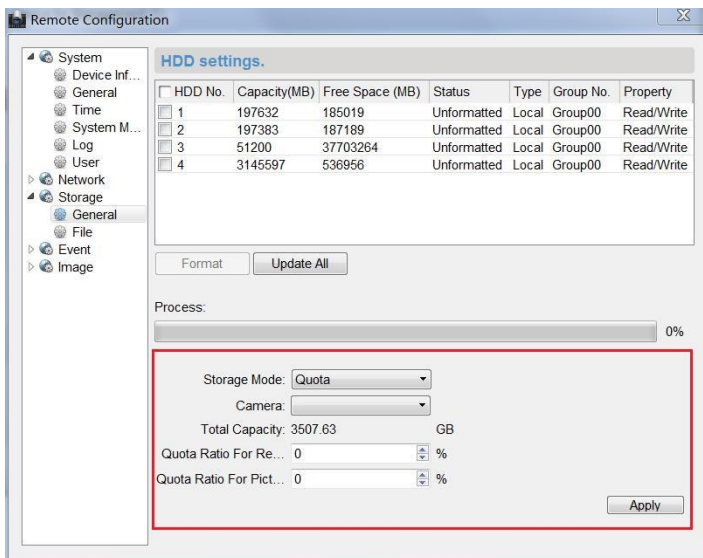

Figure 9-11 Setting Quota

**Example:** If you set the picture quota as 60%, then the 60% of the storage space can be used for storing the captured pictures.

6. Click **Save** to save the settings.

## 9.5 Video Intercom Configuration



Click the icon on the control panel of iVMS-4200 or click **View -> Video Intercom** to open the Video Intercom page. On the Video Intercom page, you can control video intercom devices remotely. There are 4 modules on the Video Intercom page:

**Video Intercom:** Start visual communication with door stations, and manage incoming calls from indoor stations and door stations and master stations. Refer *9.5.2 Video Intercom* for detail steps.

**Group Management:** Construct virtual communities according to the real community situations, and assign door stations and indoor stations to the community accordingly. Refer *9.5.1 Group Management* for detail steps.



You should manage groups first before starting the visual communication with indoor stations or door stations.

**Card Management:** Add unauthorized cards to the iVMS-4200, and issue card to the door station via the iVMS-4200. Refer 9.5.3 *Card Management* for detail steps.



Once you issue cards via the iVMS-4200, the card issuing function of the corresponding door station will be disabled automatically.

**Notice Management:** Send information to indoor stations, search information, search call logs, and search unlocking logs. Refer 9.5.4 *Notice Management* for detail steps.

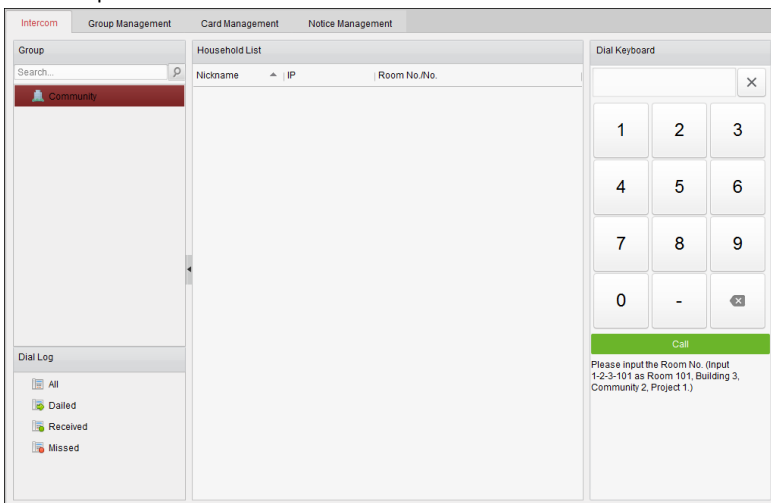

Figure 9-12 Intercom Interface

## 9.5.1 Group Management

### **Purpose:**

You can add groups to community, outer door station, or other, and assign devices to each group.

Enter **Control Panel -> Video Intercom -> Group Management** to add, edit, and delete groups. Three group types can be selected: community, outer door station and other.

### **Adding Group**

1. Click the **Group Management** tab to enter the group management interface.

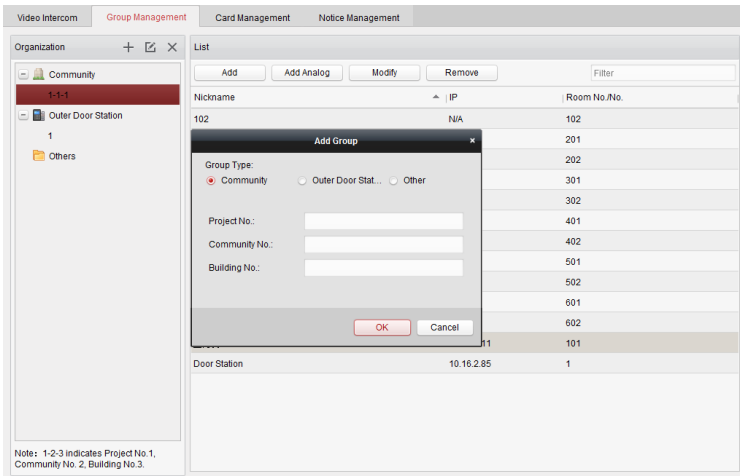

Figure 9-13 Adding Group

2. Click to pop up group adding window, and input the corresponding information accordingly.
  - Select **Community** as group type, and then Input the Community No., building No., and Unit No. to set the community structure, as shown in the figure below.

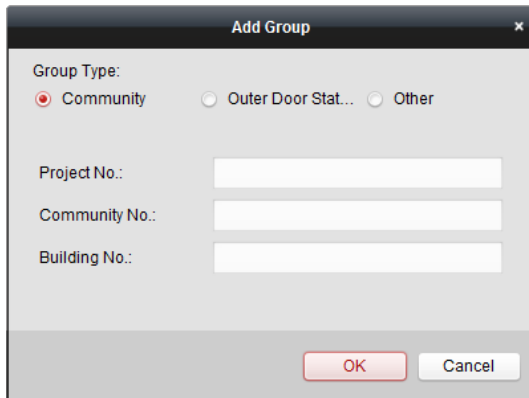

Figure 9-14 Adding Community

- Select **Outer Door Station** as group type, and then input the outer door station No. (Range: 1 to 9) to set the outer door station, as shown in the figure below.

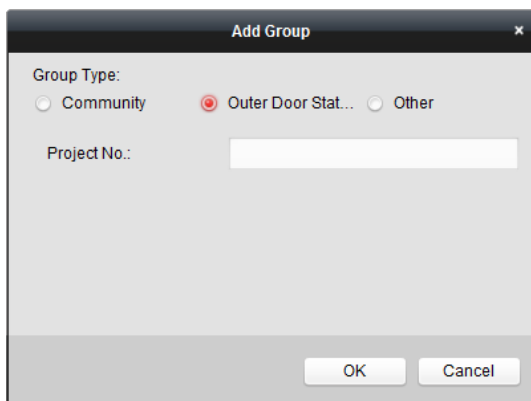

Figure 9-15 Adding Outer Door Station

- Select **Other** as group type, and then input the group name.

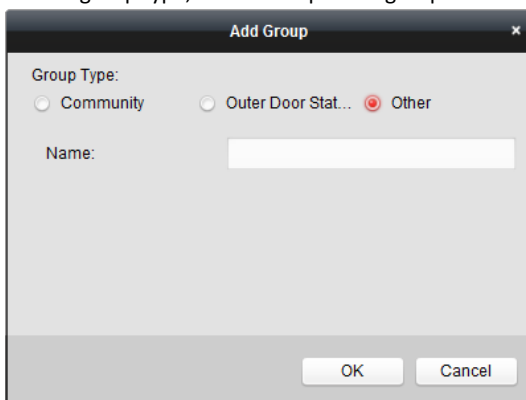

Figure 9-16 Adding Other

**For example:** You can name the group as administrator, entrance guard and cleaning staff, etc.



When selecting **Other** as the group type, you can set different groups for staff other than residents, such as administrator, security guard and cleaning staff, etc., and you can assign cards to these staff and configure different permissions to them.

3. Click **OK** to complete group adding.

## Assigning IP Devices to Group

After adding groups to Community, Outer Door Station, or Other, you should assign devices to the group.

**For example:** You should assign indoor stations and door stations to the group 1-1-1 in Community.

1. Click **Add** to enter the Add Resident Interface and the video intercom devices added to the client software will be listed, as shown in the figure below.

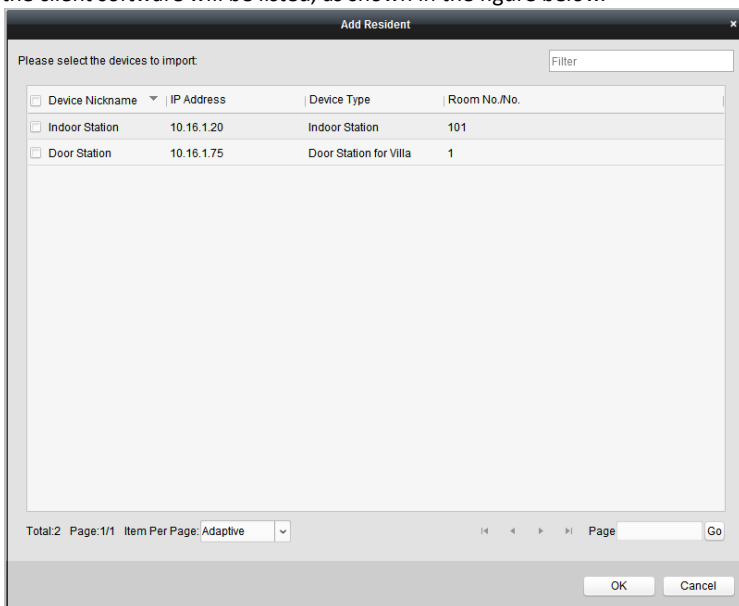

Figure 9-17 Adding Resident

2. Check the checkbox of device.
  - Indoor Station:** set a Room No. for the indoor station.
  - Door Station:** set a No. for the door station.
3. Click **OK** to save the settings.

## Assigning Analog Devices to Group



When assigning analog devices to group, only analog indoor stations are supported.

1. Click **Add Analog** to pop up analog device adding window. You can add analog devices singly or in batch.



- Adding Devices in Batch: Enter the start floor and end floor, and set the room numbers.

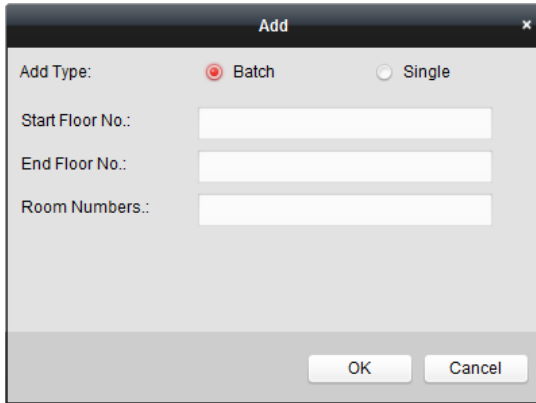

The screenshot shows a dialog box titled "Add" with a close button (X) in the top right corner. It contains the following elements:

- Add Type:** Two radio buttons are present. The "Batch" radio button is selected (indicated by a red dot), and the "Single" radio button is unselected.
- Start Floor No.:** A text input field.
- End Floor No.:** A text input field.
- Room Numbers.:** A text input field.
- Buttons:** "OK" and "Cancel" buttons are located at the bottom right of the dialog box.

Figure 9-18 Adding Devices in Batch



Room Numbers here refers to the room numbers in each floor.

- Adding Devices Singly: Enter the room No..

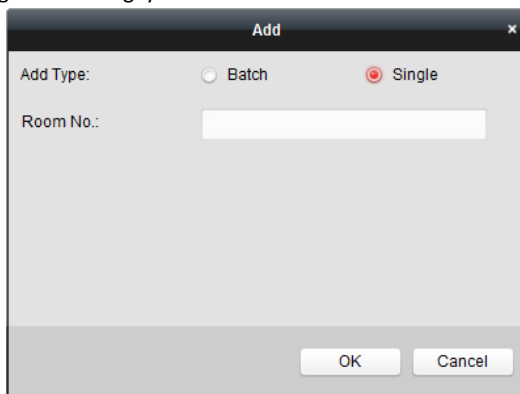

The screenshot shows a dialog box titled "Add" with a close button (X) in the top right corner. It contains the following elements:

- Add Type:** Two radio buttons are present. The "Single" radio button is selected (indicated by a red dot), and the "Batch" radio button is unselected.
- Room No.:** A text input field.
- Buttons:** "OK" and "Cancel" buttons are located at the bottom right of the dialog box.

Figure 9-19 Adding Device Singly



The room No. format is like 101.

2. Click **OK** to save the settings.

## Modifying Device Information

1. Select an added device.
2. Click **Modify** to enter the device modifying interface.

The screenshot shows a 'Modify' dialog box with the following fields and values:

|                |     |
|----------------|-----|
| Project No.:   | 1   |
| Community No.: | 1   |
| Building No.:  | 1   |
| Room No./No.:  | 101 |

Buttons: OK, Cancel

Figure 9-20 Modifying Device Information

3. Click **OK** to complete the device modifying operation.

## Deleting Device

1. Select an added device.
2. Click **Remove** to pop up a dialog box.

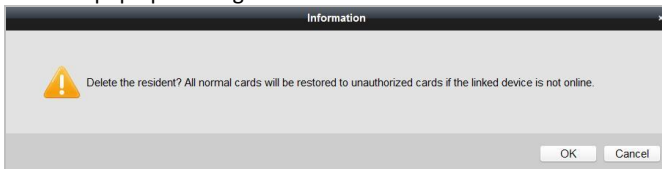

Figure 9-21 Information

3. Click **OK** to complete the group deleting operation.

## 9.5.2 Video Intercom

### Receiving Call from Indoor Station

#### **Purpose:**

When the indoor station has been added to the client software, you can call iVMS-4200 via indoor station.

#### **Before you start:**

- Make sure the indoor station has been added to the iVMS-4200 client software.

- Make sure the SIP server IP address of the indoor station is not configured (or abnormal).

**Steps:**

Press **Center** on the main interface of the indoor station.

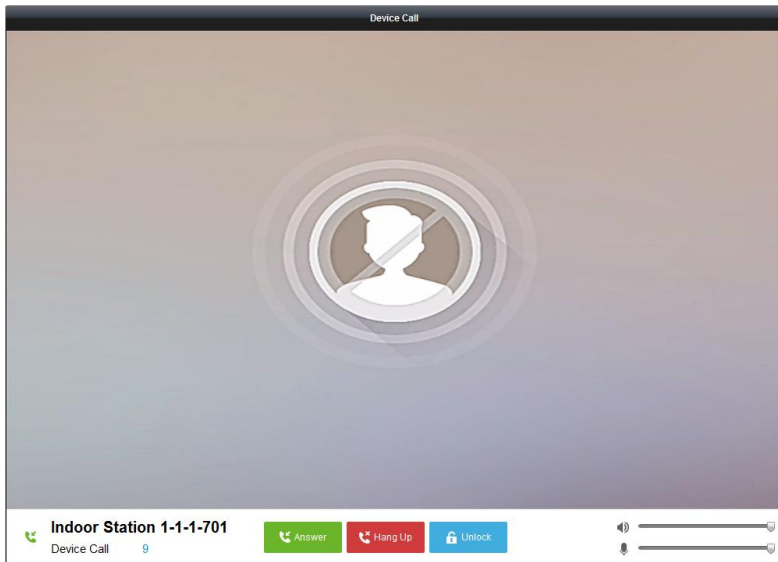

Figure 9-22 Calling from Indoor Station



- When the SIP server IP of the indoor station is configured, press **Center** on the main interface of the indoor station to call the master station instead of iVMS-4200.
- Click **Unlock** to unlock the building or villa door via iVMS-4200, no matter whether answering the call from indoor station or not.
- Click **Answer** to answer the call from indoor station.
- Click **Hang Up** to end the call from indoor station.

**Calling Indoor Station via iVMS-4200**

Enter **Control Panel-> Video Intercom-> Video Intercom** to enter the Video Intercom page.

The software provides three different methods for calling indoor station.

**Option 1: Calling Resident (Indoor Station) by Room No.**

1. Input the room No. of the indoor station in the dial keyboard on the right.

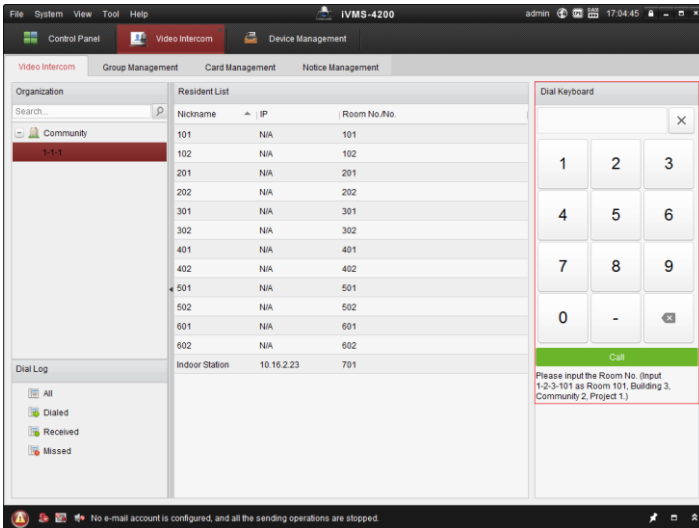

Figure 9-23 Calling Indoor Station (Option 1)



You should enter the Room No. in the correct format. For example, 1-2-3-101 refers to Room 101, Unit 2, Building 3, Community 1.

2. Click **Call** to start video call with the indoor station.

**Option 2: Calling Resident (Indoor Station) from Group**

1. Select the community from the groups on the left.

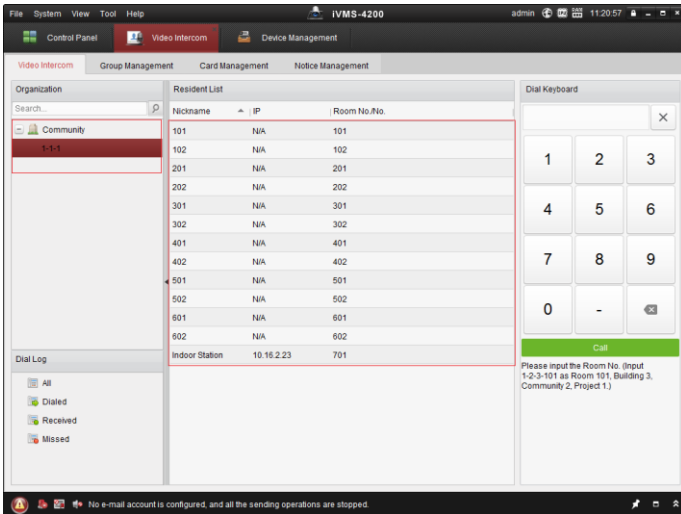

Figure 9-24 Calling Indoor Station (Option 2)

2. Double click the added resident from the resident list to call the resident.

### **Option 3: Calling Resident (Indoor Station) from Call Log**

1. Click the dial log on the below and select the log type to enter the dial log interface.

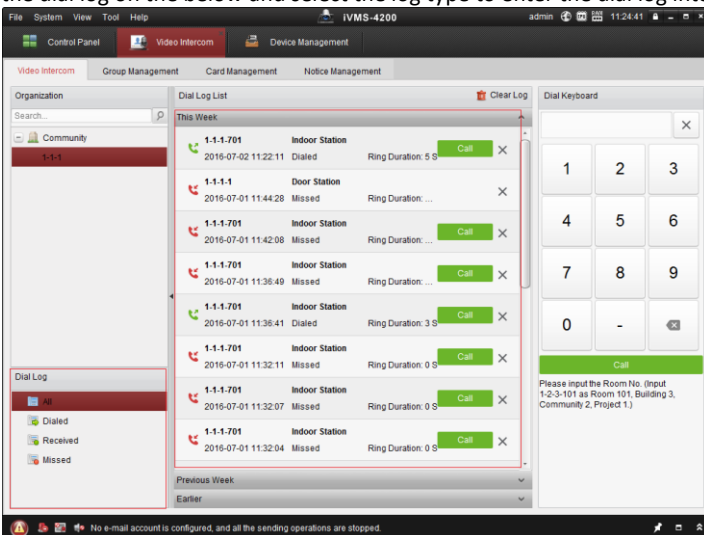

Figure 9-25 Calling Indoor Station (Option 3)

2. Click **Call** from the call logs to start video call with the indoor station.

## Call Log

On the Video Intercom tab page, there are four types of call logs you can search: **All**, **Dialed**, **Received**, and **Missed**.

On the dial log area, you can view detail information of the dialog, and click **Call** to start the audiovisual call with the indoor station.

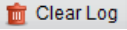
Click  to clear all logs in the list (optional).

### 9.5.3 Card Management

#### ***Purpose:***

You can add unauthorized cards to the community and then you can assign the cards to the corresponding indoor station and door stations.

For example, if there are 3 residents living in Room 401, you can assign 3 cards to No. 401 Indoor Station.

For each indoor station, you can assign multiple cards, and you can assign these cards to the door station in the same building.

**Note:** Indoor extension does not support **Card Management**.

#### ***Before you start:***

Make sure the indoor station and door station have been added to the iVMS-4200 client software.

Steps:

Click **Video Intercom** -> **Card Management** to enter the card management page.

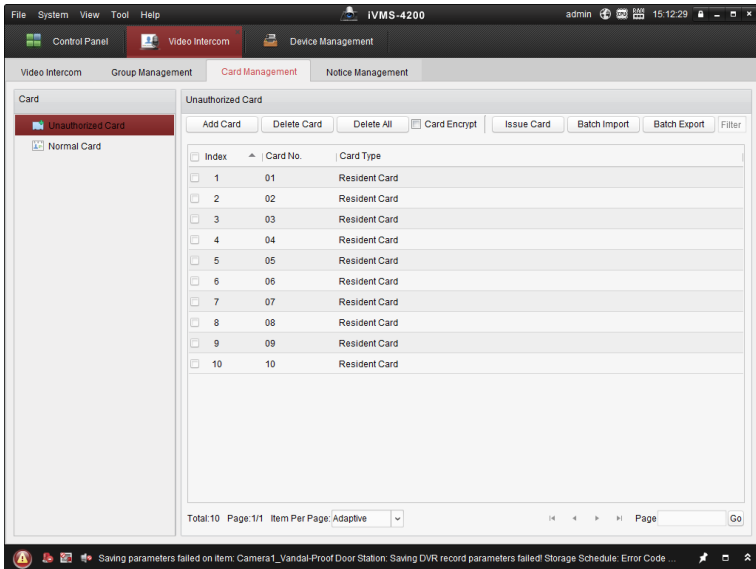

Figure 9-26 Card Management Interface

## Adding Card

### Steps:

1. Click **Unauthorized Card** -> **Add Card** to pop up card adding window.

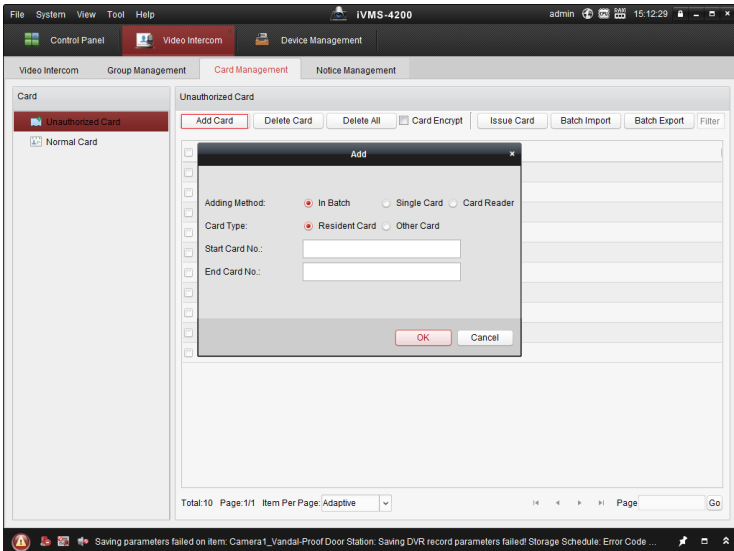

Figure 9-27 Adding Cards in Batch

2. Select card adding mode and card type.



Two types of card are available. Resident Card is used by residents living in the community, and Other Card is used by visitors (guest, serviceman, etc.) in the community.

- If you add card in batch, please set the start card No. and the end card No..
- If you add card singly, please enter the card No..
- If you add card via card reader, please swipe the card in the card reader, and the corresponding card No. will be shown automatically in the Card No. textbox.

3. Click **OK** to accomplish carding adding operation.



- Click **Delete All** to delete all cards added in iVMS-4200.
- Select one or multiple cards, and click **Delete Card** to delete selected cards added in iVMS-4200.
- **Card Encrypt** is only available to cards added via card reader. Enabling Card Encrypt can improve the card security to prevent it from being copied. But the same time, the default key of all the available sectors of the card is modified.

### Issuing Card

Click **Issue Card** to pop up card issuing window.



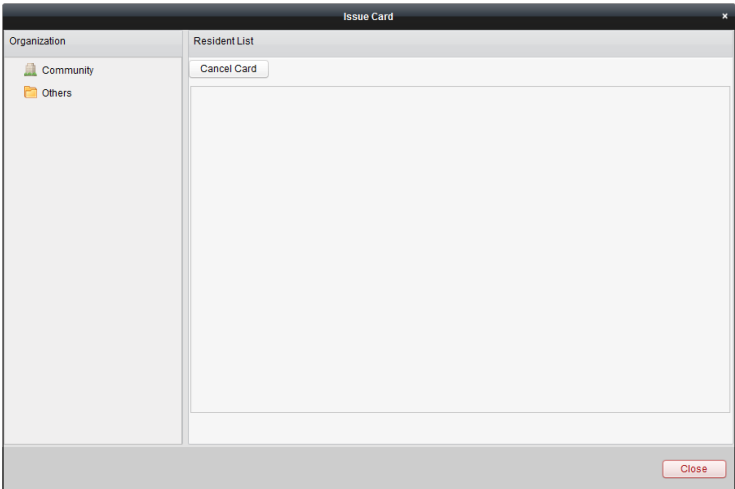

Figure 9-28 Issuing Card

### Issuing Resident Cards

**Steps:**

- 1. Select **Community** from the organization list (like 1-1-1) and the indoor stations of the community will be listed in the resident list.

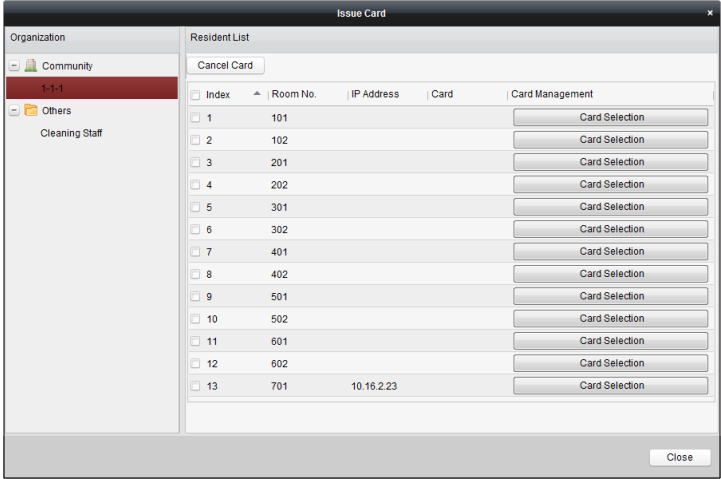

Figure 9-29 Clicking Card Selection

2. Click **Card Selection** to pop up card selection window where unauthorized resident cards are listed.

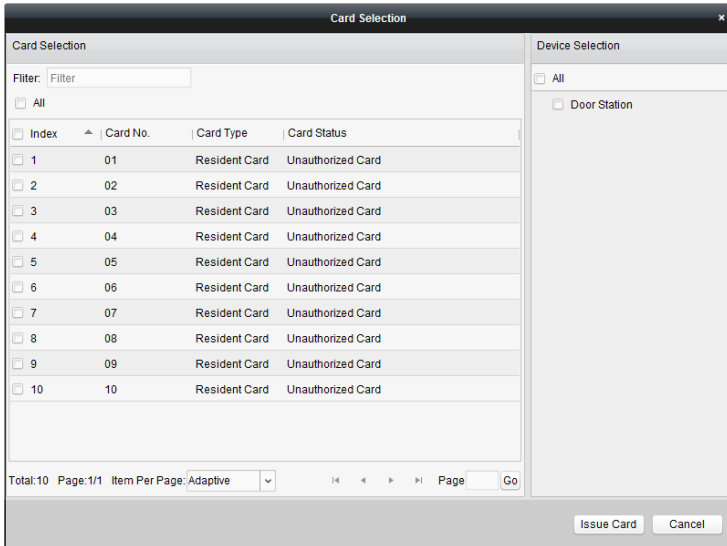

Figure 9-30 Selecting Cards

3. Check the checkboxes of the cards or enter the card No. in the filter textbox you need to assign to the indoor station, and check the checkbox of door stations, doorphones and outer door stations.



Only resident cards can be assigned to indoor stations.

4. Click **Issue Card** to complete the card issuing operation.

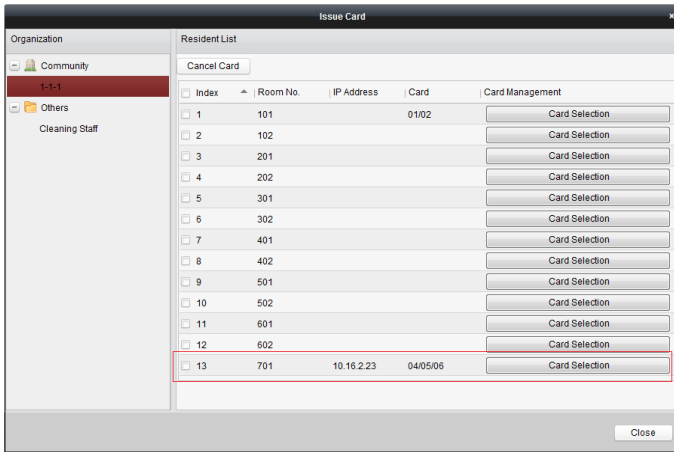

Figure 9-31 Displaying Card Issued



After issuing resident cards to the indoor station, the card No. will also be listed in the resident list.

### Issuing Other Cards

#### Steps:

1. Select **Other** from the group list (like Cleaning Staff).

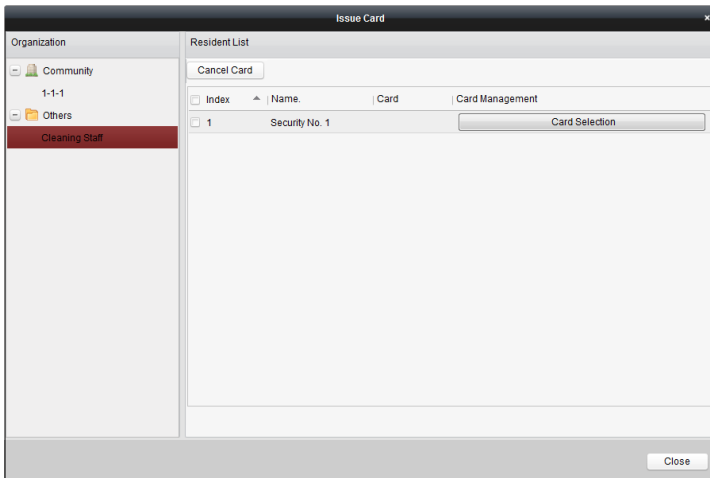

Figure 9-32 Issuing Other Card

2. Click **Card Selection** to pop up card selection window where unauthorized other cards are listed.

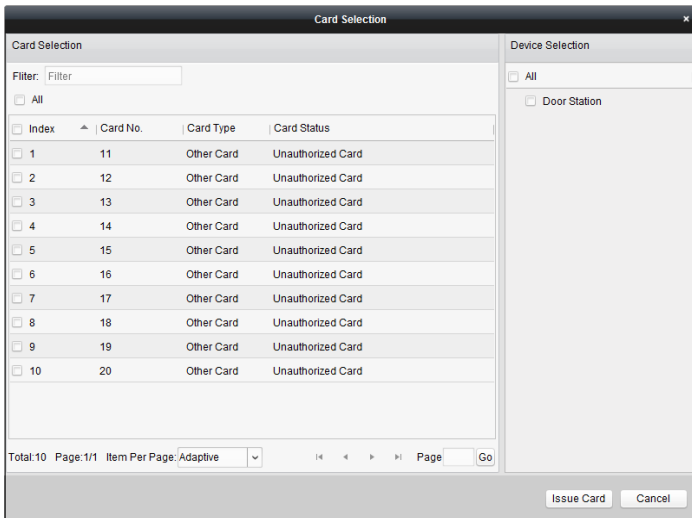

Figure 9-33 Selecting Cards

3. Check the checkboxes of the cards or enter the card No. in the filter textbox you need to assign to the person, and check the checkbox of door stations, doorphones and outer door stations.
4. Click **Issue Card** to complete the card issuing operation.

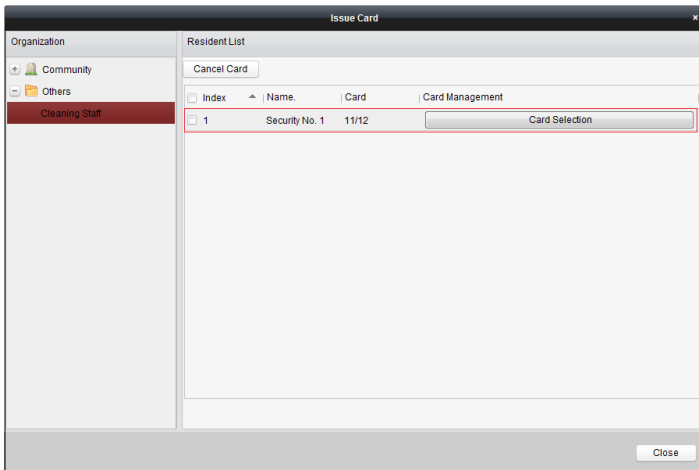

Figure 9-34 Displaying Card Issued



After issuing other cards to the person, the card No. will also be listed in the resident list page.

**Canceling Cards**

When canceling cards, cards that have been issued will be reset to authorized ones. Via iVMS-4200, there are two ways to cancel the cards which have been issued.

**Option 1:**

**Steps:**

1. Select **Community** from the organization list (like 1-1-1) and the indoor stations of the community will be listed in the resident list.

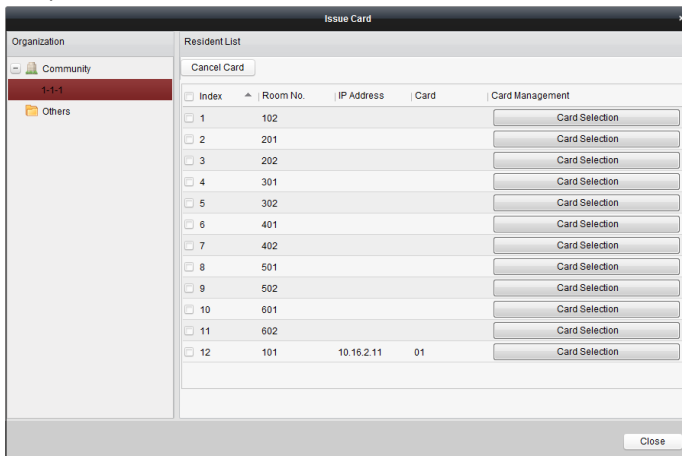

Figure 9-35 Card Selection Interface

2. Click **Card Selection** to pop up card selection window where normal cards and unauthorized resident cards are listed.

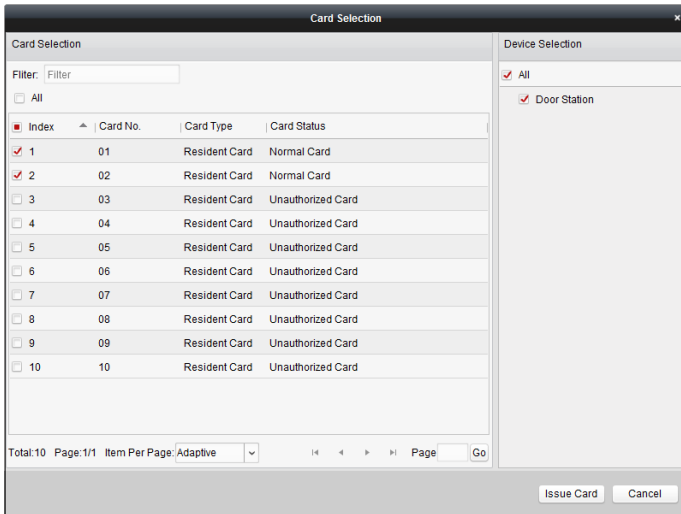

Figure 9-36 Selecting Cards

3. Check the checkboxes of the cards that has been issued (normal cards).
4. Click **Issue Card** to complete the card canceling operation.

**Option 2:**

On the card issuing interface, check the checkboxes of Room No. (for resident card) or Name (for other card), click **Cancel Card** to cancel all card issued to the device.



- Through Option 1, you can cancel card from single or certain door stations.
- Through Option 2, you will cancel all issued cards at a time.

**Normal Card**

Click **Normal Card** to display normal card list. After issuing cards, the issued cards will be listed in the normal card list, as shown in the figure below.

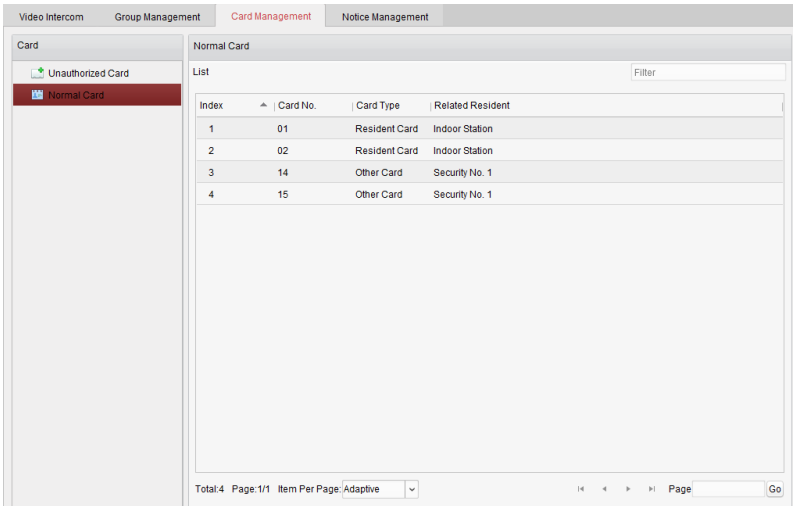

Figure 9-37 Normal Cards Interface

## Batch Importing Unauthorized Cards

### Steps:

1. Click **Batch Import** to enter the batch import interface, as shown in the figure below.

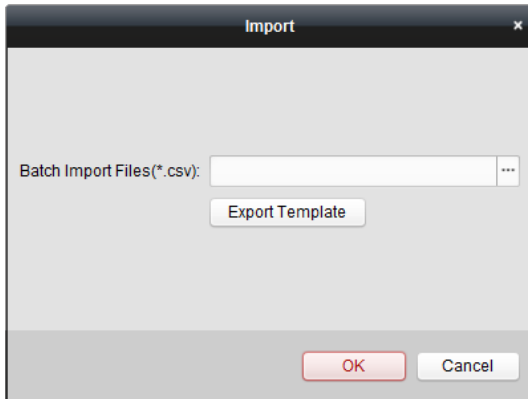



Figure 9-38 Importing File

2. Click **Export Template** to export the template of the batch import file.
3. Fill in the template of the batch import file and save it.
4. Click  to select the batch import file and click Open.

5. Click **OK** to start importing the batch import file.

## Batch Exporting Unauthorized Cards

### Steps:

1. After adding unauthorized cards, and click **Batch Export**.
2. Select the saving file path and click **Save**.
3. After batch exporting the unauthorized cards, the excel will be generated in the saving directory.

## 9.5.4 Notice Management

### Creating Notice Information

#### Purpose:

You can create notice information and send it to residents (indoor stations).

#### Steps:

1. Click **Notice -> Create Notice Information** to enter the notice information creating page.

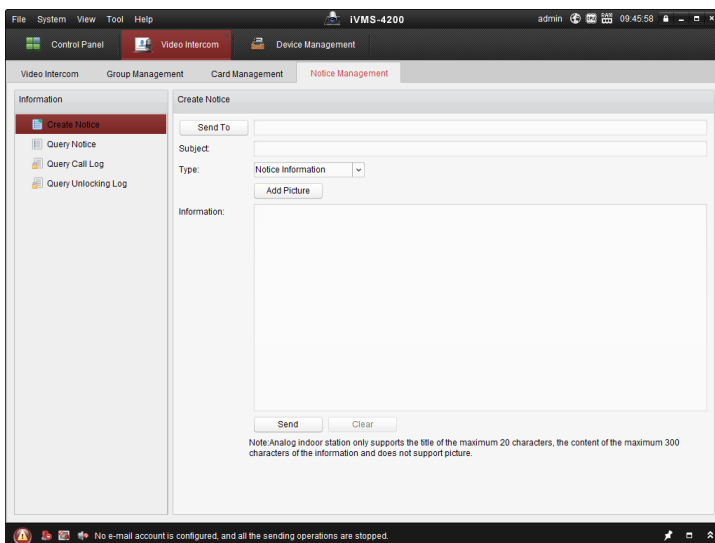

Figure 9-39 Notice Creation Interface

2. Click **Send To** to pop up the residents (indoor stations) selection window. Check the checkboxes of indoor stations you want to send information to, and click **OK**.



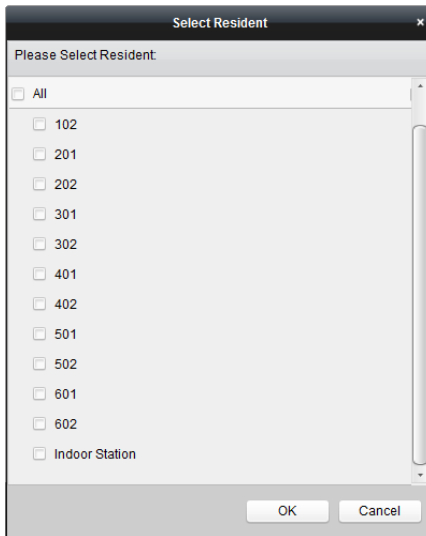

Figure 9-40 Selecting Residents

3. Enter the subject, set the information type, and add the picture (optional).
4. Enter the information and click **Send** to send the notice.



- For IP indoor stations, no more than 63 characters (including space) can be input in the field of subject. For analog indoor stations, no more than 20 characters (including space) can be input in the field of subject.
- For IP indoor stations, no more than 1023 characters (including space) can be input in the field of information. For analog indoor stations, no more than 300 characters (including space) can be input in the field of information.
- Only picture with size smaller than 512KB and with format of jpg. can be added to the notice, and no more than 6 pictures can be added to the same notice information.
- Analog indoor stations do not support receiving pictures.

## Querying Notice Information

### **Purpose:**

You can search the notice information send to residents.

### **Steps:**

1. Select **Query Notice Information** to enter query notice information interface.
2. Select the info type, input the subject, recipient, and set the start time and end time.

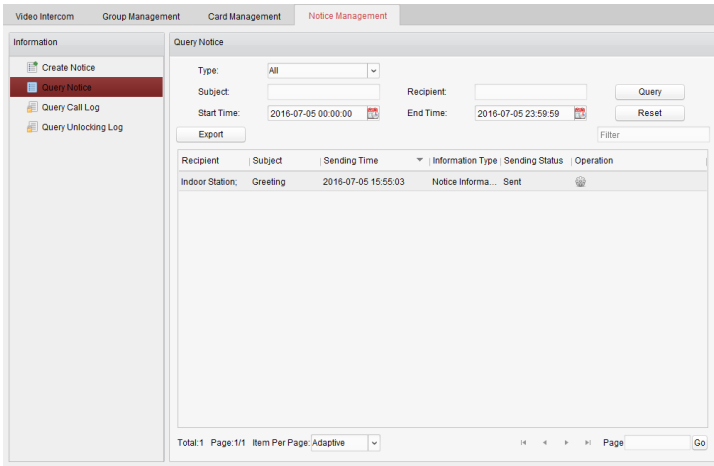

Figure 9-41 Notice Interface

3. Click **Query** to search the notice information.
4. Click to view the detailed information of selected notice. You can resend the notice information failed to be received or unread by residents.

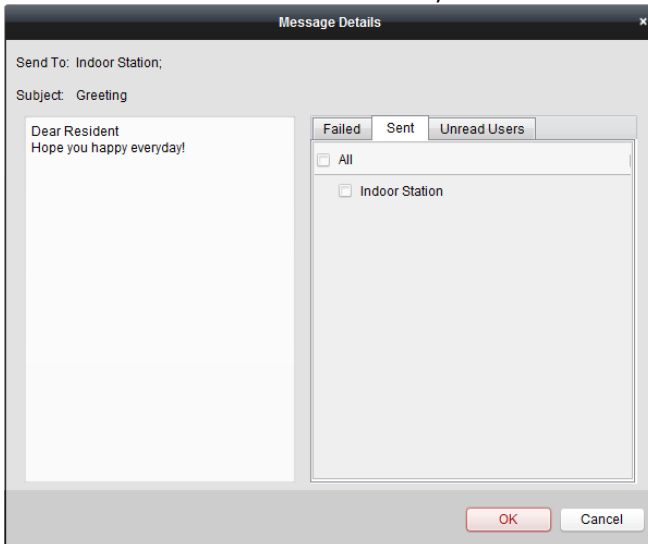

Figure 9-42 Message Details

5. Click **Export** to export the notice information.

## Querying Call Logs

### Steps:

1. Click **Query Call Logs** to enter the call log querying page.
2. Select the calling status, device type, and set the start time and end time, and click **Query** to search the call log.

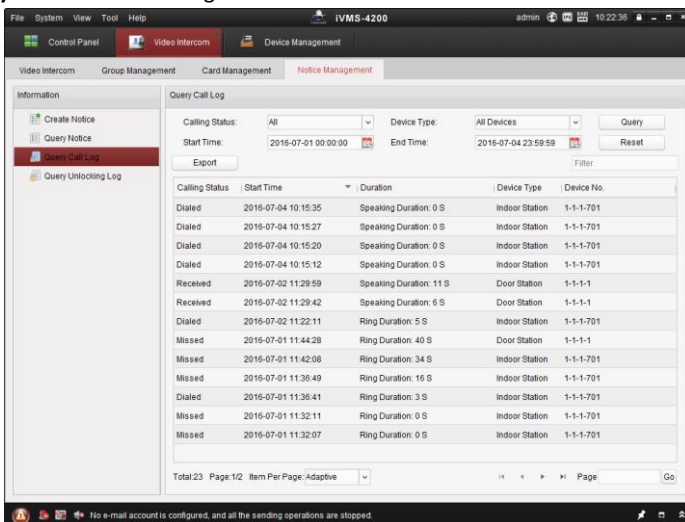

Figure 9-43 Call Log Interface

3. Click **Export** to export the call logs as an excel file.

## Querying Unlocking Log

### Steps:

1. Click **Query Unlocking Logs** to enter the unlocking log querying page.
2. Select the unlocking type, device type, and set the start time and end time, and click **Query**.

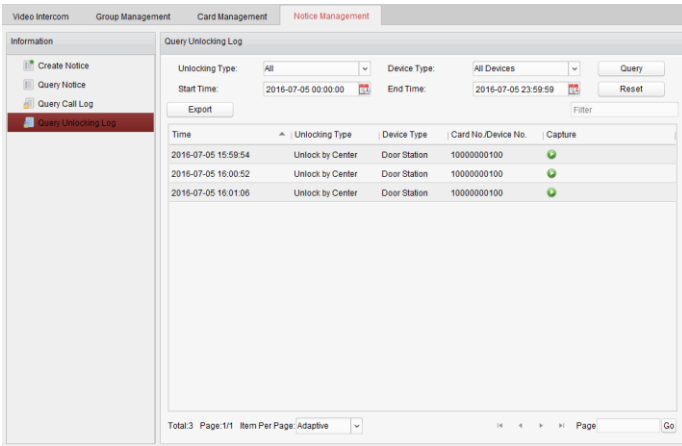

Figure 9-44 Unlocking Log Interface

3. Click **Export** to export the unlocking logs as an excel file.

## 9.6 Device Arming Control

### Steps:

1. Select **Tool->Device Arming Control** to pop up device arming control window.



Figure 9-45 Tool Bar

- Set the arming status of the device as armed, and the alarm information will be auto uploaded to the client software when alarm occurs.

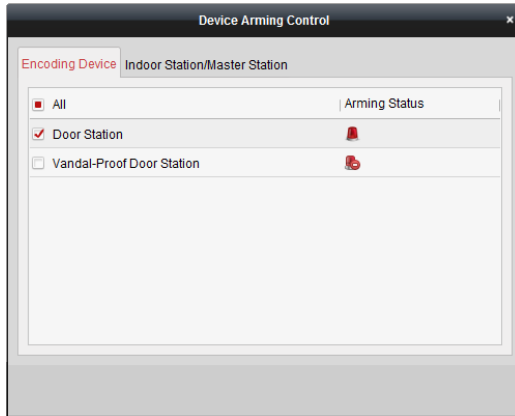

Figure 9-46 Device Arming Control

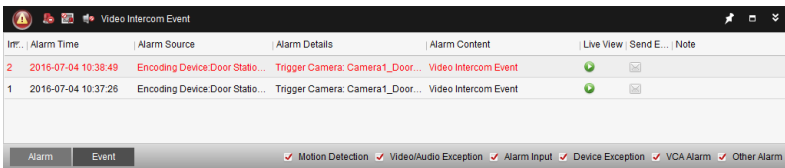

Figure 9-47 Alarm Events



After adding the device to the client software, it will be armed automatically.

## 10 Accessing via Hik-Connect Mobile Client Software



- The Hik-Connect mobile client software supports the iOS system and Android system both.
- The basic operations of the client software are similar on the iOS system and on the Android system. Here we take operations on the iOS system as example.

### 10.1 Installing Software

#### 10.1.1 Installing Software (iOS)

**Steps:**



1. Log in the **App Store**.
2. Enter the key words **Hik-Connect** to search the mobile client software.
3. Download and install the software to your iPhone.
4. After installing the software, tap  to run it.

#### 10.1.2 Installing Software (Android)

**Step:**

1. Log onto the **Google Play**.
2. Enter the key words **Hik-Connect** to search the mobile client software.
3. Download and install the software to your phone.
4. After installing the software, tap  to run it.



To uninstall the software, tap and hold the software icon  until the icon turns to , and tap the **delete** icon on the upper-left corner to delete the software.

### 10.2 Registering Software

**Purpose:**

You should register the software first before logging in the software.

Two ways of registration are available: Registration via Telephone No., and Registration via E-Mail Address. Here we take Registration via Telephone No. as example to introduce registering an account in the software.

**Steps:**

1. Tap the icon  to run the software, and tap **Register an Account** to enter registration mode selection interface.



Figure 10-1 Main Interface

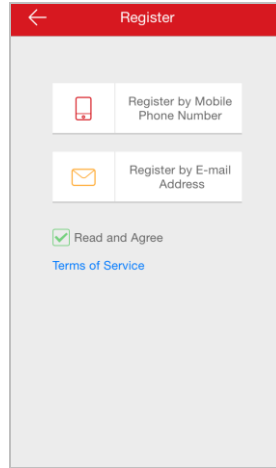

Figure 10-2 Selecting Registration Mode

2. Tap **Terms of Service**, and check the checkbox of **Read and Agree** if you agree the Agreement.
3. Tap **Register by Mobile Phone Number**, to enter the region selection interface.

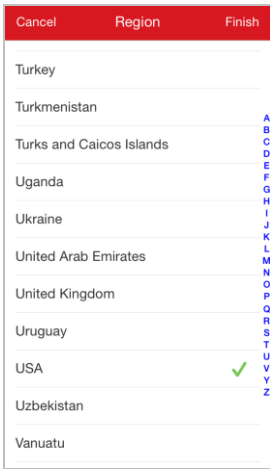

Figure 10-3 Selecting Region

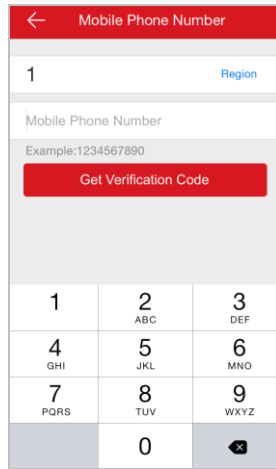

Figure 10-4 Entering Phone No.

4. Select a target region, enter a valid mobile phone No., and tap the **Get Verification Code** button. The verification code will be sent to your phone.

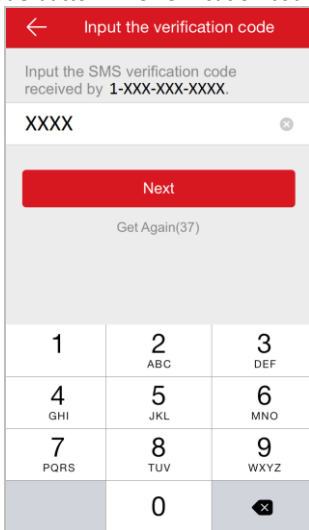

Figure 10-5 Entering Code

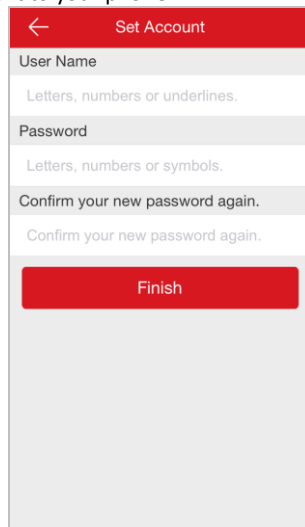



Figure 10-6 Setting Account

5. Enter the received verification code, and tap the **Next** button to enter the account creating interface. On the account creating interface, enter a user name, a password, a confirm password, and tap the **Finish** button to complete account registration.



## 10.3 Logging in Software

### Steps:

1. Tap the icon  to run the software.
2. Enter the user name/e-mail address, and enter the password.
3. Tap the **Login** button to log in the software.



- If you want to login via mobile phone No., please tap **Login with mobile phone number**.
- If you forget the password, please tap **Forgot Password** to find the password.

## 10.4 Adding Device

Two ways of adding device are available: Adding Device by Scanning QR Code, and Adding Device by Inputting Device Serial No..

### 10.4.1 Adding Device via QR Code

#### Steps:

1. On the Home screen, tap the icon .
2. Scan the device QR code to pop up the device information page, and tap the **Add** button.

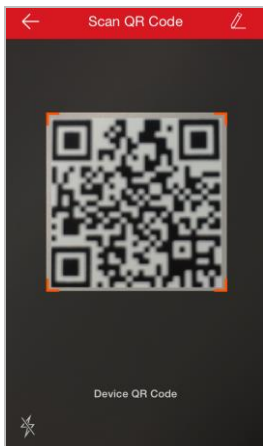

Figure 10-7 Scanning QR Code

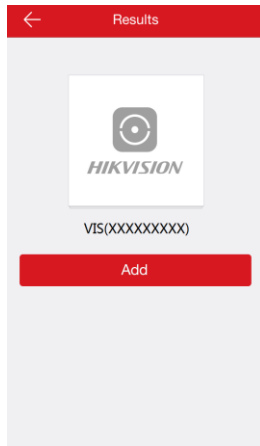

Figure 10-8 Device Result

3. Enter the device verification code, tap the **OK** button, and finish the device adding.

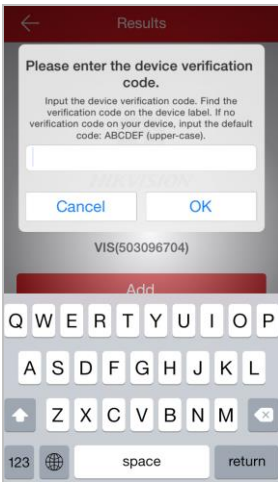

Figure 10-9 Entering Code

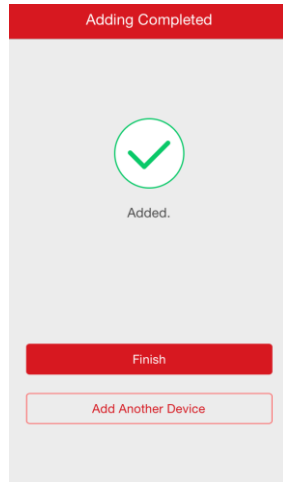



Figure 10-10 Device Added

### 10.4.2 Adding Device via Serial No.

**Steps:**

1. On the Home screen, tap the icon , and tap the icon .
2. Enter the serial No. of the device to pop up the device information page, and tap the **Add** button.

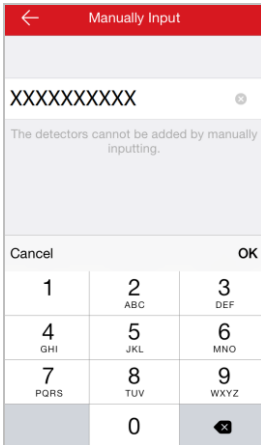

Figure 10-11 Scanning QR Code

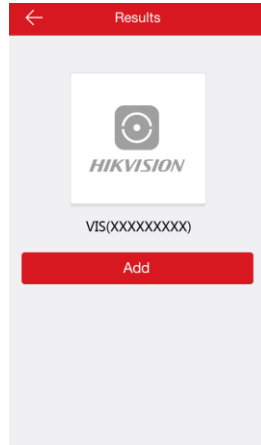

Figure 10-12 Device Result

3. Enter the device verification code, tap the **OK** button, and finish the device adding.

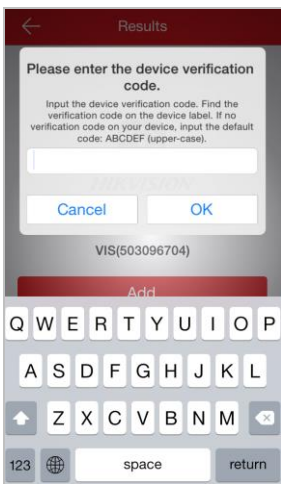

Figure 10-13 Entering Code

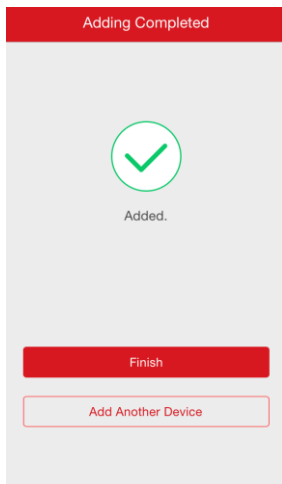

Figure 10-14 Device Added



- The serial No. of the device is on the label stuck on the rear panel of the device.
- The default device verification code is **ABCDEF**.

## 10.5 Live View and Remote Unlocking









After adding the device, go the Home page, and tap a camera to enter the live view interface.



Figure 10-15 Live View Page

On the live view page, you can control the intercom device remotely. See the following table in detail.

Table 10-1 Icon Description

| Keys  | Description                     |
|---|---------------------------------|
|  | Enable the live view.           |
|  | Disable the live view.          |
|  | Enable/disable the audio.       |
|  | Switch to the full-screen mode. |
|  | Switch to the 4-screen mode.    |
|  | Zoom in.                        |
|  | Remote unlock.                  |
|  | Capture the live view image.    |
|  | Enable/disable recording.       |

## Appendix

### Installation Notice

While installing the indoor station, please make sure that the distance between any two devices is far as possible to avoid the howling and echo. The distance between two devices is recommended to be more than 10 meters.



Here the devices refer to indoor station, outdoor station and master station.

### Wiring Cables

| Cable                                    | Specification       |
|--|---------------------|
| Power Cord of Door Station               | RVV 2*1.0           |
| Network Cable of Door Station            | UTP-five Categories |
| Door Lock Wiring (With Door Magnetic)    | RVV 4*1.0           |
| Door Lock Wiring (Without Door Magnetic) | RVV 2*1.0           |
| Exit Button Wiring                       | RVV 2*0.5           |
| External Card Reader Wiring              | RVVP 4*0.75         |



First Choice for Security Professionals